

**NEW PORT**  
14-091-250  
25.0 cm



**BREISKY SPECULUM**

- 14-092-001 100 x 20mm
- 14-093-002 100 x 25mm
- 14-094-003 100 x 30mm
- 14-095-004 100 x 35mm
- 14-096-005 100 x 40mm

- 14-097-006 130 x 20mm
- 14-098-007 130 x 25mm
- 14-099-008 130 x 30mm
- 14-100-009 130 x 35mm
- 14-101-010 130 x 40mm
- 14-102-011 155 x 40mm

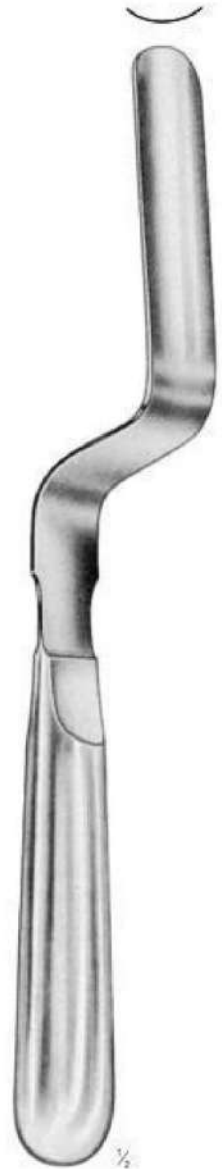

**LANDAU SPECULUM**

- 14-103-001 105 x 28 mm
- 14-104-002 105 x 38 mm



**TUFFRO**

The Mangalm Surgical Co.



**O'SULLIVAN - O'CONNOR**  
Set of Complete 14-107-001  
14-108-002  
14-109-003  
14-110-004



**14-108-002**  
45 x 17 mm



**14-109-003**  
90 x 37 mm



**14-110-004**  
90 x 45 mm



**ABDOMINAL RETRACTOR**  
14-111-090 9 cm wide  
14-112-100 10 cm wide  
14-113-115 11.5 cm wide



**FRIEDMANN**  
14-114-100  
10 cm

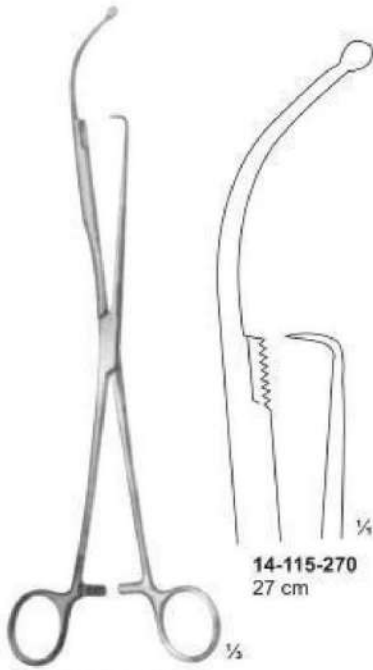

14-115-270  
27 cm

**HULKA GYNE**

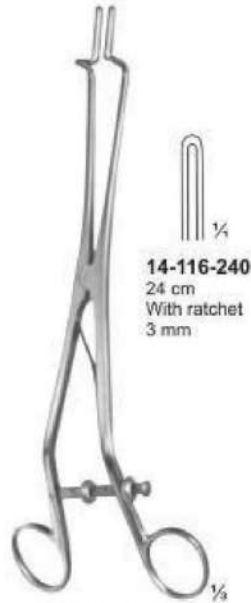

14-116-240  
24 cm  
With ratchet  
3 mm

**KOGAN GYNE**



**KOGAN**  
14-117-240  
24.0 cm



**KOGAN**  
14-118-240  
24.0 cm

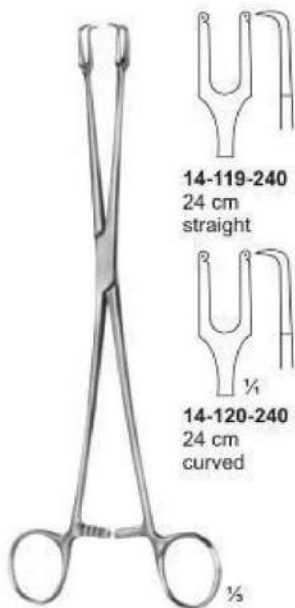

14-119-240  
24 cm  
straight

14-120-240  
24 cm  
curved

**SCHRÖDER GYNE**

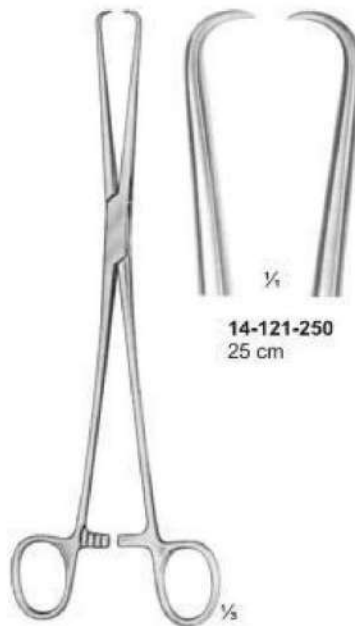

14-121-250  
25 cm

**SCHRÖDER**

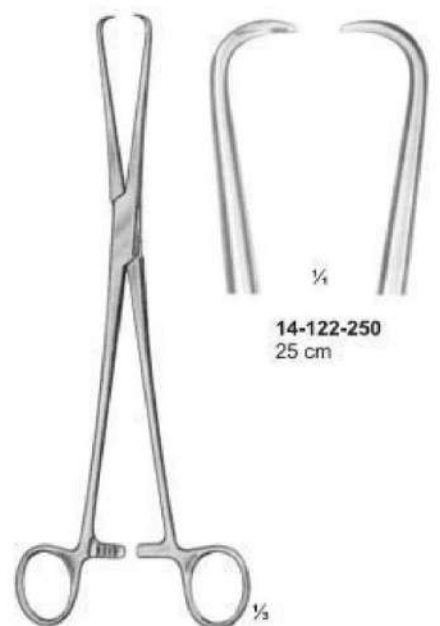

14-122-250  
25 cm

**POZZI GYNE**



**TUFFRO**

The Mangalm Surgical Co.



**BARRETT**  
14-123-180  
18 cm



**SAIRGES**  
14-124-230  
23 cm



**MUSEUX**  
24 cm



**MUSEUX**  
24 cm

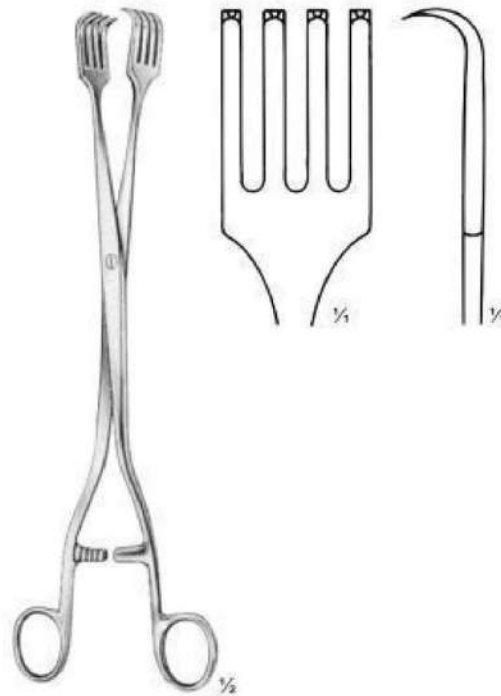
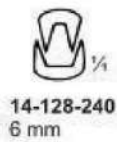

**PRATT**  
14-131-280  
28 cm



**TEALE**  
14-132-230  
23 cm



**JACOBS**  
14-133-210  
21 cm  
Straight



**IOWA**  
14-134-260  
26 cm



**DARTIGUES**  
14-135-270  
27 cm

For polypus forcepssee  
Section 6.

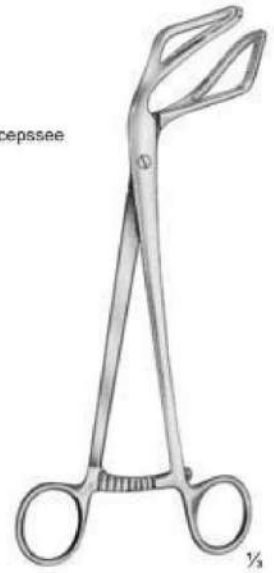

**SOMER**  
14-136-230  
23 cm



**DOYEN**  
14-137-170  
17 cm



**DOYEN**  
14-138-170  
17 cm

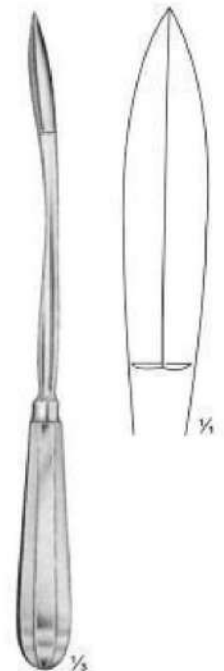

**SEGOND**  
14-139-270  
27 cm



**BRAUN**  
14-140-280  
28 cm



**SIMS**  
14-141-260  
26 cm

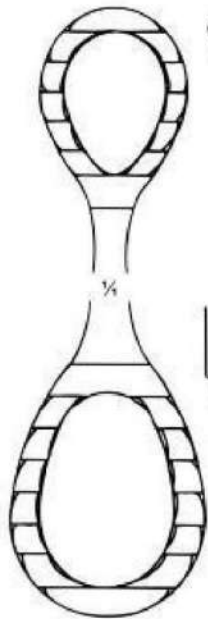

**KEVORKIAN**



14-142-300  
30 cm  
1.2mm



14-143-300  
30 cm  
4.0 mm  
Without Basket



14-144-300  
30 cm  
4.0 mm  
With Basket



**BLAKE**  
14-145-270  
27 cm

Sharp

Blunt



**COLLIN**  
28 cm



14-146-280  
8.0 mm



14-147-280  
10.0 mm



14-148-280  
12.0 mm

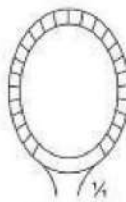

14-149-280  
14.0 mm



**SIMON/  
SCHRODER**



Fig. 1  
14-150-250 25 cm  
14-151-300 30 cm



Fig. 2  
14-152-250 25 cm  
14-153-300 30 cm



Fig. 3  
14-154-250 25 cm  
14-155-300 30 cm



Fig. 4  
14-156-250 25 cm  
14-157-300 30 cm



Fig. 5  
14-158-250 25 cm  
14-159-300 30 cm



Fig. 6  
14-160-250 25 cm  
14-161-300 30 cm



**GOURDET**  
28.0 cm



Fig. 1  
14-162-280



Fig. 2  
14-163-280



Fig. 3  
14-164-280



Fig. 4  
14-165-280



Fig. 5  
14-166-280



**TUFFRO**

The Mangalm Surgical Co.

**Recamier/  
Sims**

Sharp

Sharp/  
Blunt

Sharp/  
Blunt



31 cm 1/2



31 cm 1/2



31 cm 1/2



31 cm 1/2



**SIMS UTERINE  
CURETTE**

14-223-250

single ended, sharp  
as above but blunt  
25 cm three sizes  
small, medium, large



**SIMS UTERINE  
CURETTE.**

14-224-250

double ended, sharp  
25 cm long.



**SIMS UTERINE  
CURETTE**

14-225-250

double ended, sharp  
and blunt ends.  
25 cm long.

5.0 mm	14-167-310	14-181-310	14-195-310	14-209-310
6.0 mm	14-168-310	14-182-310	14-196-310	14-210-310
7.0 mm	14-169-310	14-183-310	14-197-310	14-211-310
8.0 mm	14-170-310	14-184-310	14-198-310	14-212-310
9.0 mm	14-171-310	14-185-310	14-199-310	14-213-310
11.0 mm	14-172-310	14-186-310	14-200-310	14-214-310
12.0 mm	14-173-310	14-187-310	14-201-310	14-215-310
14.0 mm	14-174-310	14-188-310	14-202-310	14-216-310
15.0 mm	14-175-310	14-189-310	14-203-310	14-217-310
16.0 mm	14-176-310	14-190-310	14-204-310	14-218-310
19.0 mm	14-177-310	14-191-310	14-205-310	14-219-310
20.0 mm	14-178-310	14-192-310	14-206-310	14-220-310
21.0 mm	14-179-310	14-193-310	14-207-310	14-221-310
23.0 mm	14-180-310	14-194-310	14-208-310	14-222-310



**SIMS**  
14-226-320  
32 cm  
right  
malleable

**SIMS-SPECIAL**  
14-227-320  
32 cm

**SIMS**  
schwed. Modell  
14-228-260  
26 cm

**MARTIN**  
14-229-300  
30 cm

**VALLEIX**  
14-230-250  
25 cm

**GALABIN  
UTERINE  
SOUND**  
14-231-292  
malleable, shaft  
graduated in cms.  
Silver plated,  
29.2 cm

**HORROCKS  
UTERINE  
SOUND**  
14-232-001  
malleable, shaft  
graduated in cms.  
Silver plated,

**NOVAK "SUCTION  
CANNULA  
CURETTE"**  
14-233-254  
Luer cone,  
25.4 cm





**PRATT GYNE**



1/4

**PRATT GYNE**

**14-234-001**

Set of 8 Double ended  
size 13/14 thru 41/43  
4.5/5.0mm thru 13.6/14.3mm

- 14-235-001 04.5/05.0 mm
- 14-236-002 05.6/06.3 mm
- 14-237-003 07.0/07.6 mm
- 14-238-004 08.3/09.0 mm
- 14-239-005 09.6/10.3 mm
- 14-240-006 11.0/11.6 mm
- 14-241-007 12.3/13.0 mm
- 14-242-008 13.6/14.3 mm



1/4

**HEGAR**

**14-243-001**

Set of 8 dilator  
3.0/4.0 mm - 17.0/18.0 mm

**14-244-002**

Set of 13 dilator  
1.0/2.0 mm - 25.0/26.0 mm



**HANK**

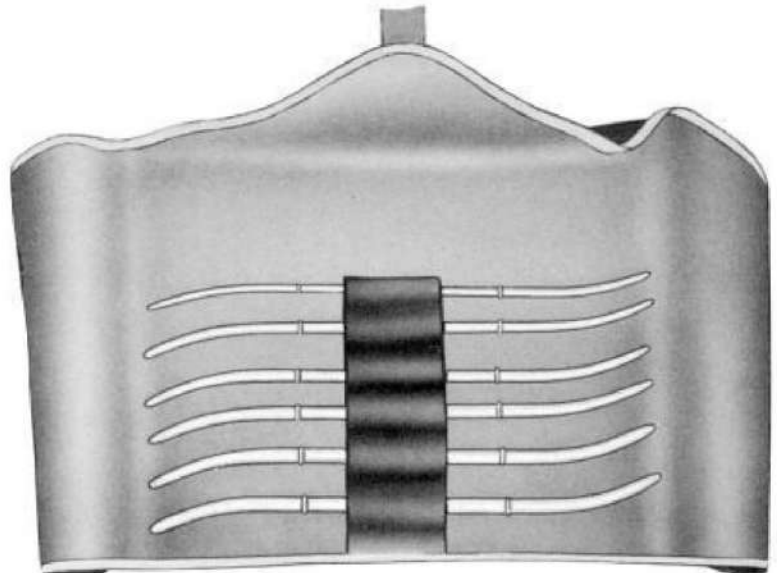

1/4

**HANK GYNE**

**14-251-001**

Set of 6 dilators  
4.5/5.0 mm - 9.5/10.0 mm

- 14-245-001 4.5/05.0 mm
- 14-246-002 5.5/06.0 mm
- 14-247-003 6.5/07.0 mm
- 14-248-004 7.5/08.0 mm
- 14-249-005 8.5/09.0 mm
- 14-250-006 9.5/10.0 mm



**TUFFRO**

The Mangalm Surgical Co.



**14-252-001**  
Set of 8 dilators  
3.0/4.0 mm - 17.0/18.0 mm  
**14-253-002**  
Set of 13 dilators  
1.0/2.0 mm - 25.0/26.0 mm

**HEGAR GYNE**

- 14-254-001** 01.0/02.0 mm
- 14-255-002** 03.0/04.0 mm
- 14-256-003** 05.0/06.0 mm
- 14-257-004** 07.0/08.0 mm
- 14-258-005** 09.0/10.0 mm
- 14-259-006** 11.0/12.0 mm
- 14-260-007** 13.0/14.0 mm
- 14-261-008** 15.0/16.0 mm
- 14-262-009** 17.0/18.0 mm
- 14-263-010** 19.0/20.0 mm
- 14-264-011** 21.0/22.0 mm
- 14-265-012** 23.0/24.0 mm
- 14-266-013** 25.0/26.0 mm



**HEGAR GYNE**

**14-267-001**  
Set of 8 dilators  
3.0/4.0 mm - 17.0/18.0 mm



- 14-268-001** 1 mm
- 14-269-002** 2 mm
- 14-270-003** 3 mm
- 14-271-004** 4 mm
- 14-272-005** 5 mm
- 14-273-006** 6 mm
- 14-274-007** 7 mm
- 14-275-008** 8 mm
- 14-276-009** 9 mm
- 14-277-010** 10 mm
- 14-278-011** 11 mm
- 14-279-012** 12 mm
- 14-280-013** 13 mm
- 14-281-014** 14 mm
- 14-282-015** 15 mm
- 14-283-016** 16 mm
- 14-284-017** 17 mm
- 14-285-018** 18 mm
- 14-286-019** 19 mm
- 14-287-020** 20 mm
- 14-288-021** 21 mm
- 14-289-022** 22 mm
- 14-290-023** 23 mm
- 14-291-024** 24 mm
- 14-292-025** 25 mm
- 14-293-026** 26 mm
- 14-294-027** 27 mm
- 14-295-028** 28 mm
- 14-296-029** 29 mm
- 14-297-030** 30 mm

**14-299-001**  
Set of 14 dilators  
4.0 mm - 17.0 mm

- 14-300-001** 1.5 mm
- 14-301-002** 2.5 mm
- 14-302-003** 3.5 mm
- 14-303-004** 4.5 mm
- 14-304-005** 5.5 mm
- 14-305-006** 6.5 mm
- 14-306-007** 7.5 mm
- 14-307-008** 8.5 mm
- 14-308-009** 9.5 mm
- 14-309-010** 10.5 mm
- 14-310-011** 11.5 mm
- 14-311-012** 12.5 mm
- 14-312-013** 13.5 mm
- 14-313-014** 14.5 mm
- 14-314-015** 15.5 mm
- 14-315-016** 16.5 mm
- 14-316-017** 17.5 mm
- 14-317-018** 18.5 mm
- 14-318-019** 19.5 mm

**HEGAR GYNE**

**14-298-001**  
Set of 26 dilators  
1.0 mm - 26.0 mm



**HEGAR GYNE**

**14-319-001**  
Set of 14 dilators  
4.0 mm - 17.0 mm

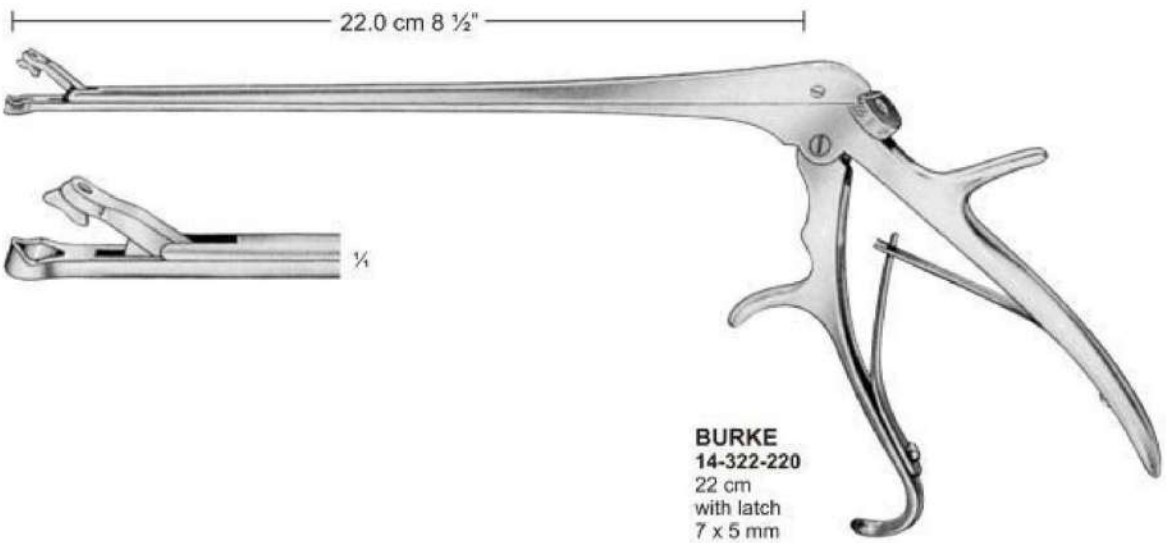
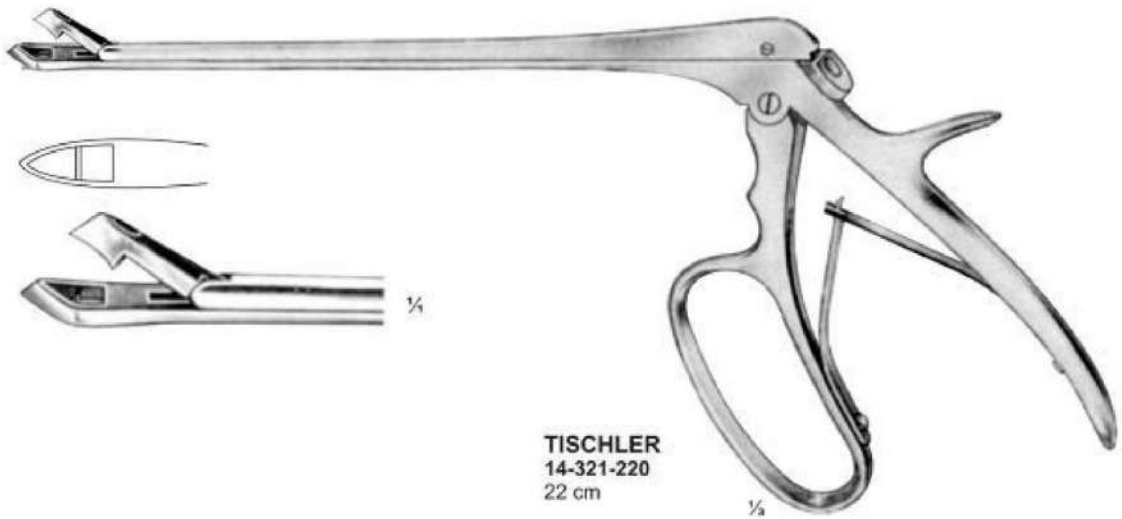
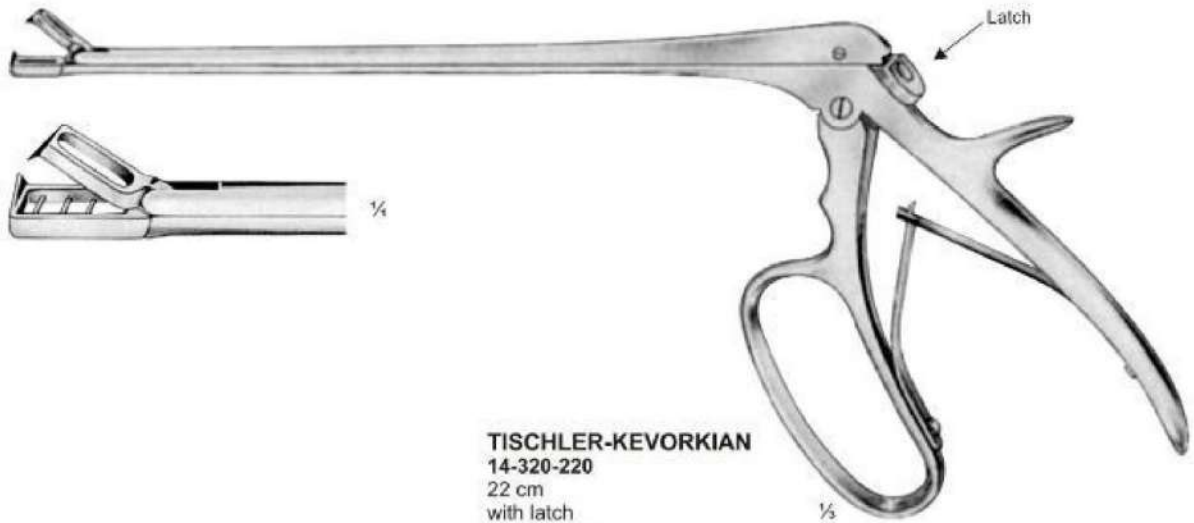

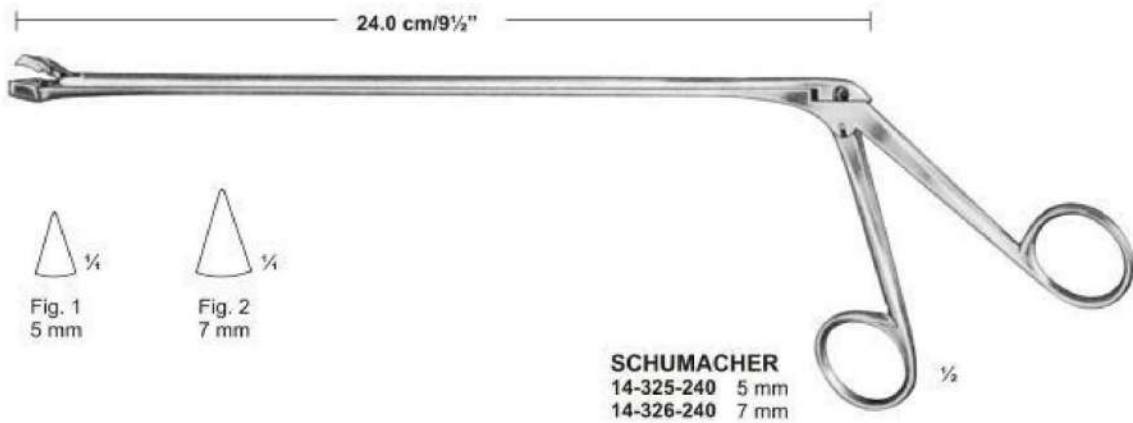
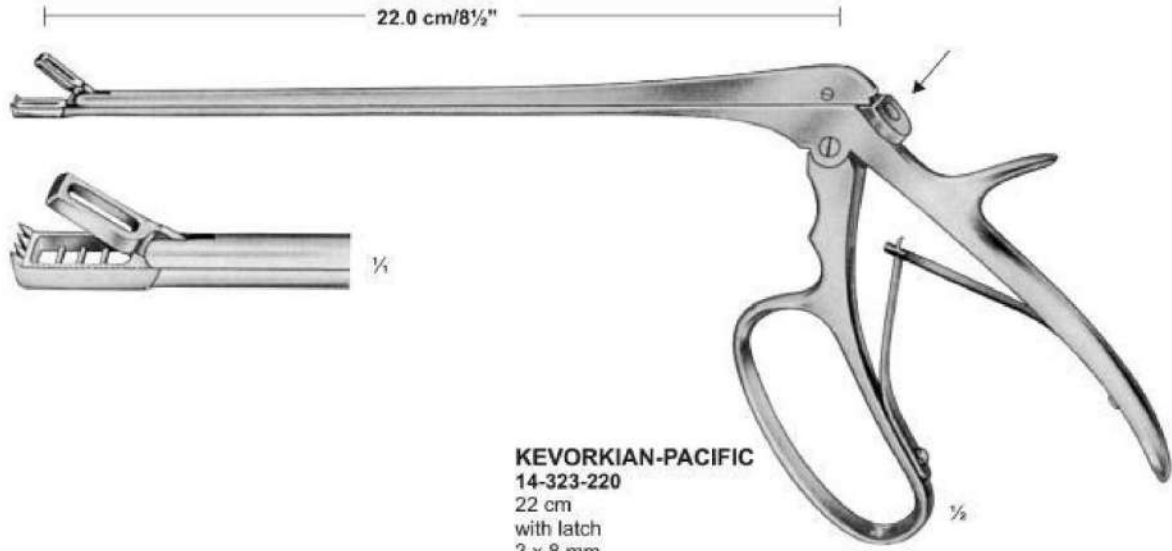

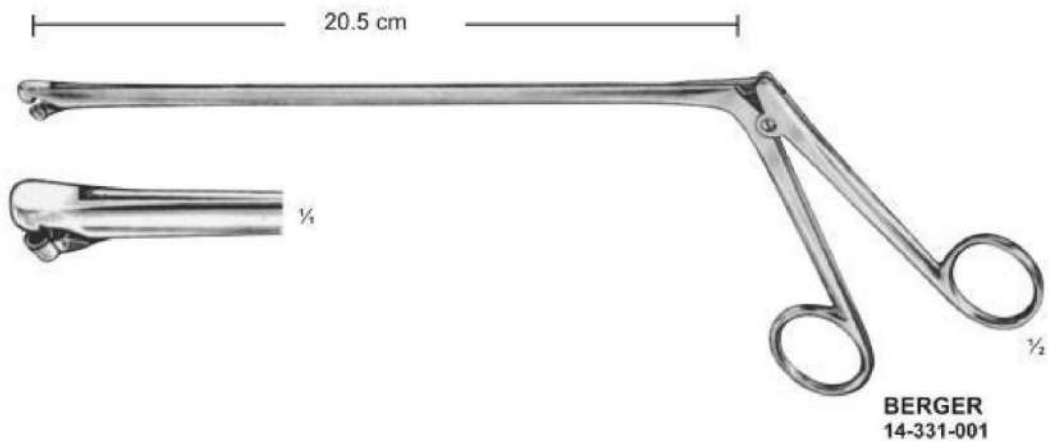
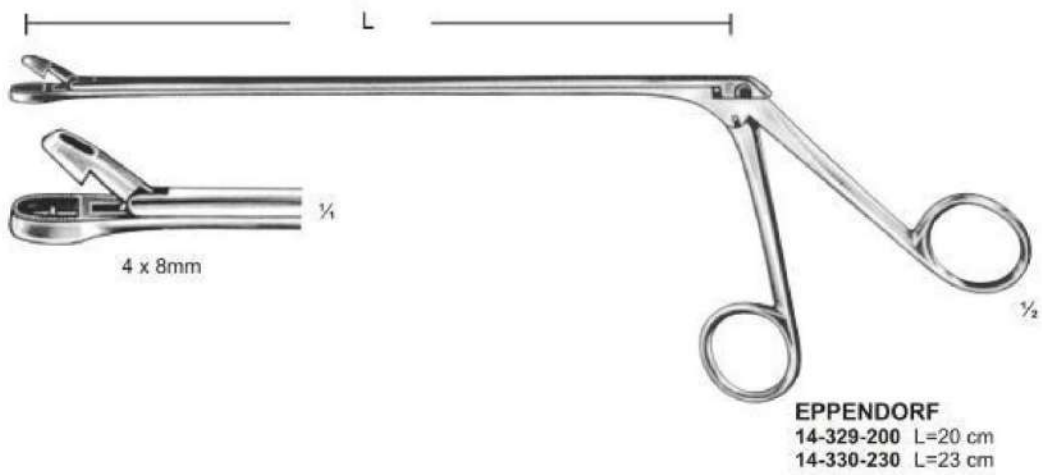
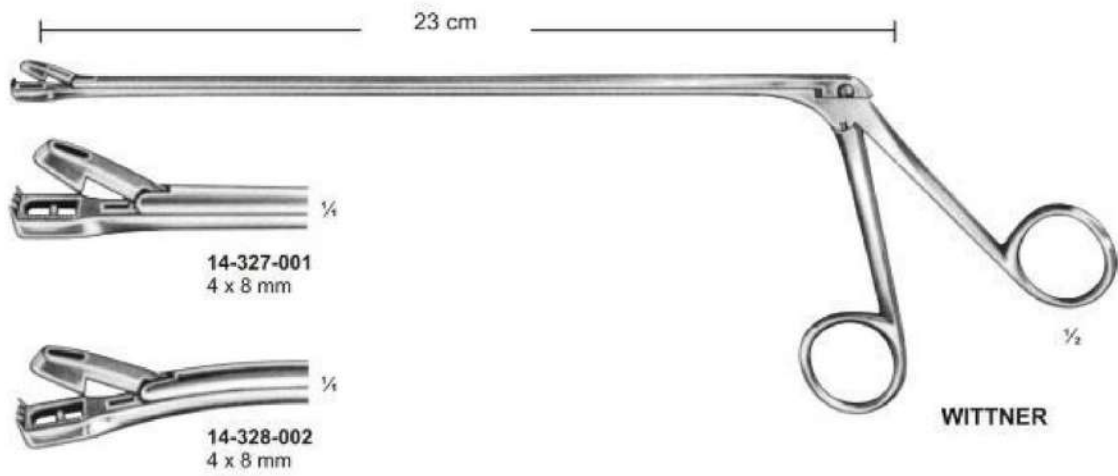



**TUFFRO**

The Mangalm Surgical Co.

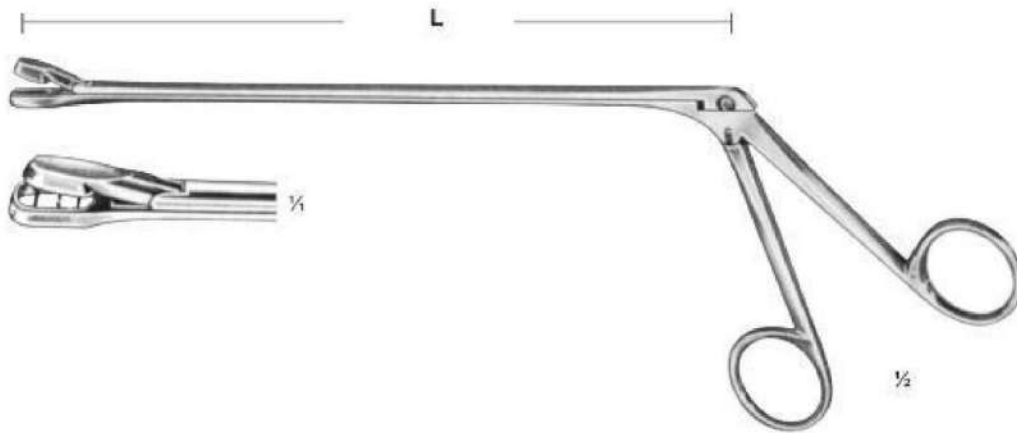

**DOUAY**

- 14-332-200 L=20 cm
- 14-333-250 L=25 cm
- 14-334-300 L=30 cm
- 14-335-350 L=35 cm
- 14-336-400 L=40 cm

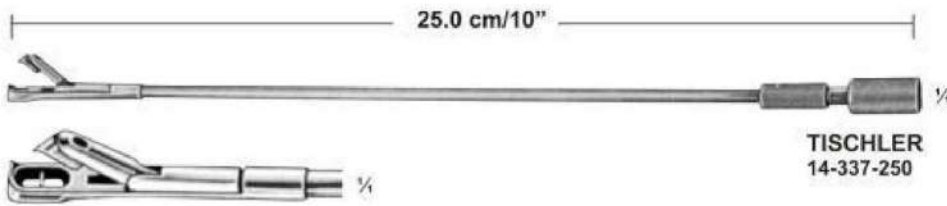

**TISCHLER**  
14-337-250

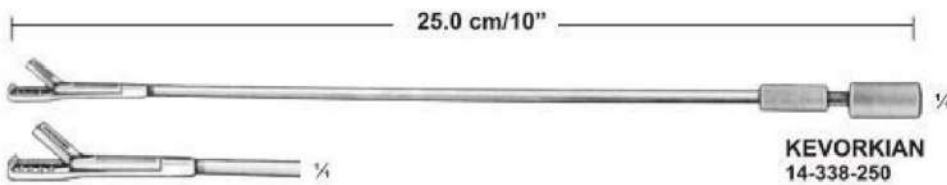

**KEVORKIAN**  
14-338-250

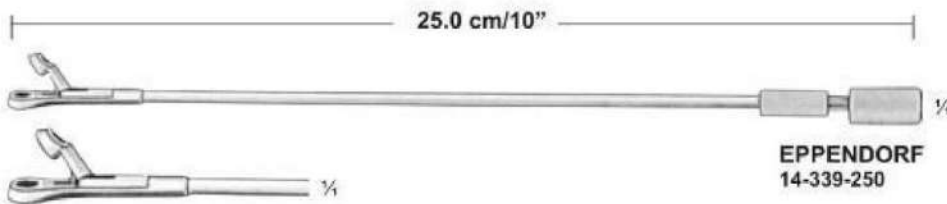

**EPPENDORF**  
14-339-250

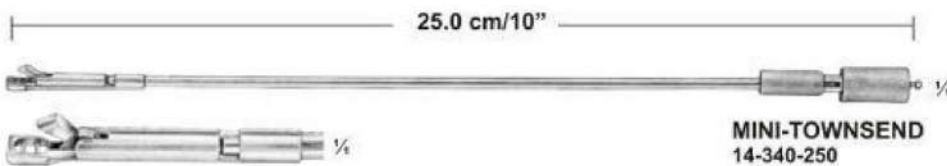

**MINI-TOWNSEND**  
14-340-250

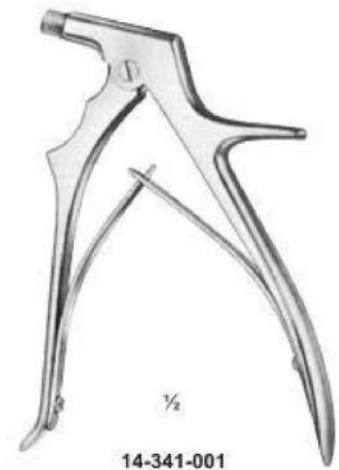

14-341-001

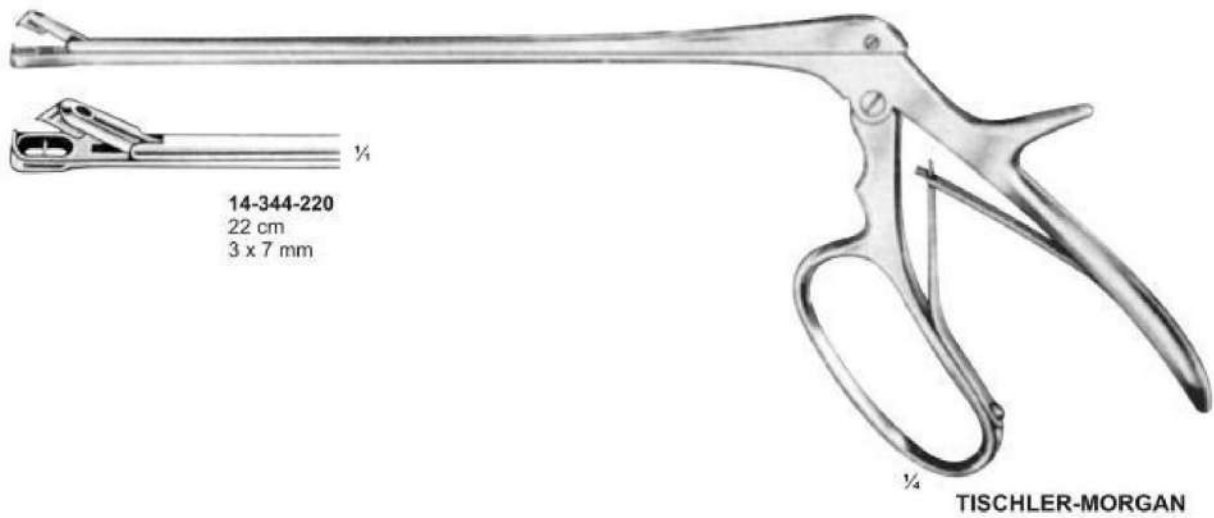
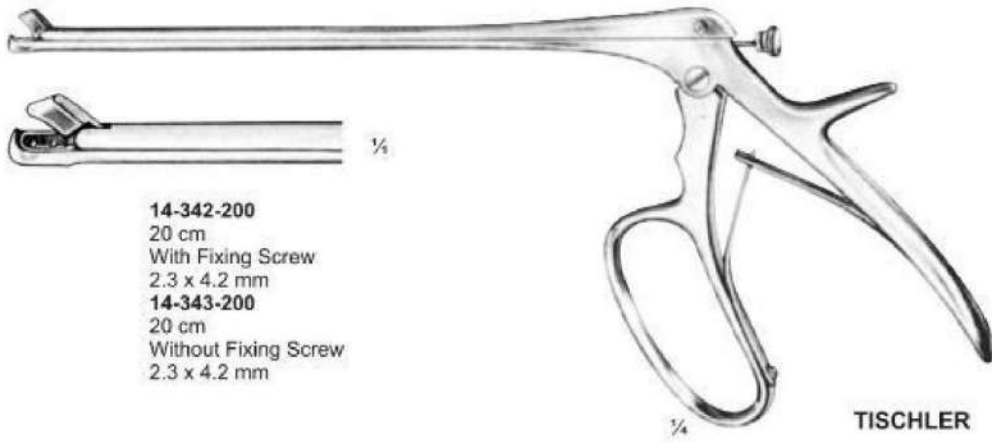



**GELLHORN**  
14-347-230  
23 cm



**FAURE**  
14-348-230  
23 cm



**SCHUBERT**  
14-349-210 21 cm  
14-350-280 28 cm



**THOMS-GAYLOR**  
14-351-240  
24 cm



**SCHUBERT**  
14-352-260  
26 cm

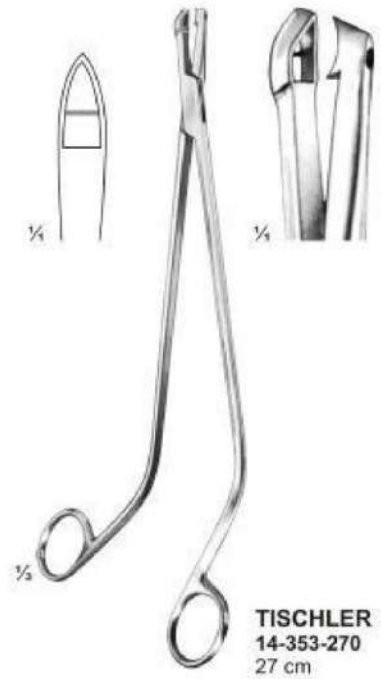

**TISCHLER**  
14-353-270  
27 cm



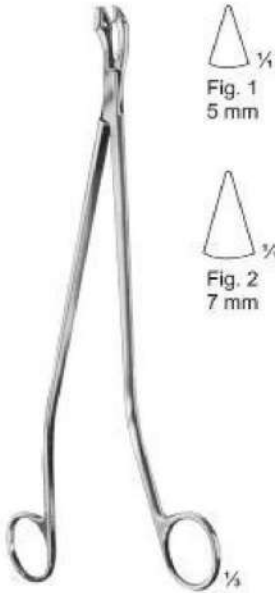

**SCHUMACHER-NAN-DOREN**  
14-354-240 Fig. 1  
14-355-240 Fig. 2  
24 cm



**VAN DOREN**  
14-356-250  
25 cm



**VAN DOREN**  
14-357-250  
25 cm



**NAEGELE**  
14-358-250  
25 cm



**SPELLIE**  
14-359-250  
25 cm



**BRAUN**  
14-360-300  
30 cm



**SPELLIE**  
14-361-300  
30 cm

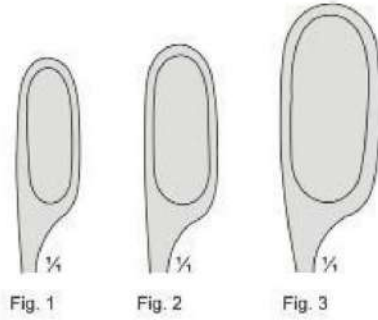

**WINTER**  
14-362-280 Fig. 1  
14-363-280 Fig. 2  
14-364-280 Fig. 3  
28 cm



**WINTER**  
14-365-280 Fig. 1  
14-366-280 Fig. 2  
14-367-280 Fig. 3  
28 cm

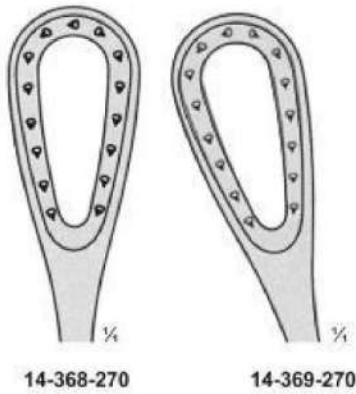
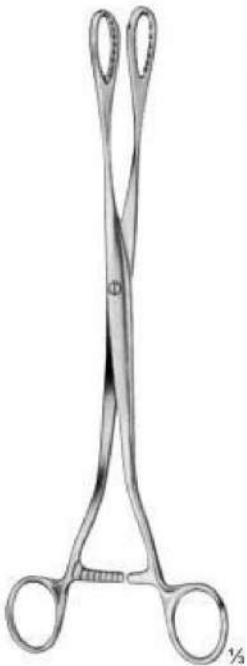

**SAENGER**  
27 cm

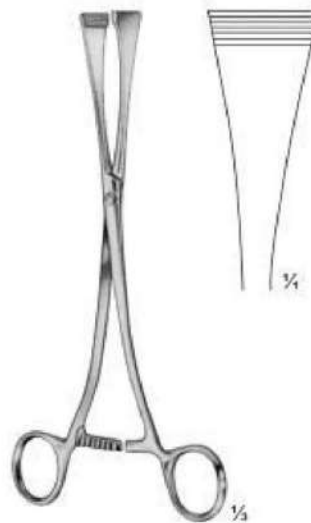

**GREEN-ARMYTAGE**  
14-370-210  
21 cm



**WALLICH**  
14-371-420  
42 cm



**MARTIN**  
14-372-340  
34 cm



**SIMPSON**  
14-373-300  
30 cm



**PIPER**  
14-374-440  
44 cm



**NAEGELE**  
14-375-360 36 cm  
14-376-400 40 cm



**SIMPSON**  
14-377-230  
23 cm

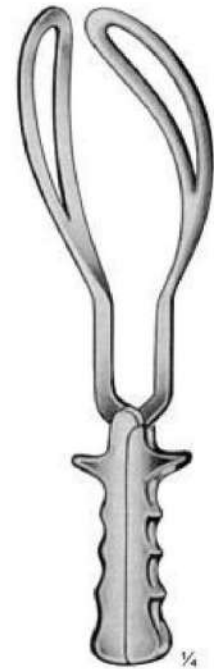

**SIMPSON-BRAUN**  
14-378-260  
36 cm



**MCLEAN**  
14-379-260  
36 cm



**KIELLAND**  
14-380-410  
41 cm



**KIELLAND-LUIKART**  
14-381-410  
41 cm



**WRIGLEY**  
14-382-230  
23 cm



**DE LEE**  
14-383-300  
30 cm

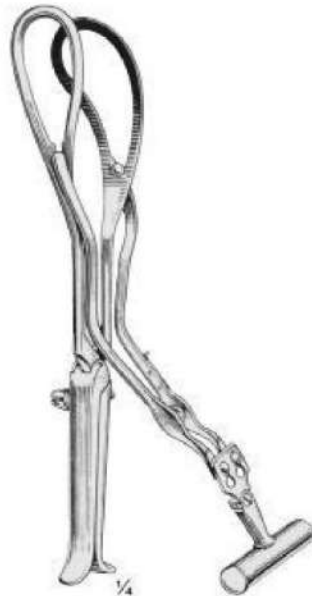

**MILNE MURRAY  
MIDWIFERY FORCEPS**  
14-384-001  
detach-able axis traction rod  
& handle.

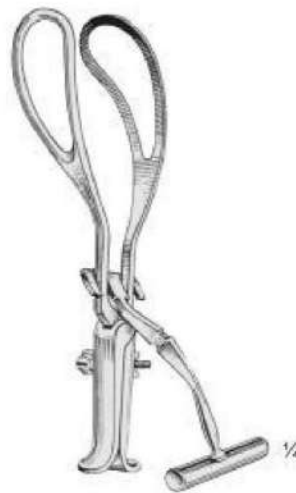

**HAIG FERGUSON  
MIDWIFERY FORCEPS**  
14-385-001  
detachable axis traction rod & handle.



**BARNES-NEVILLE  
MIDWIFERY FORCEPS**  
14-386-001  
Simpson handles, detachable axis  
traction rod and handle.



**TUFFRO**

The Mangalm Surgical Co.

# SECTION - 14

## GYNECOLOGY / OBSTETRICS

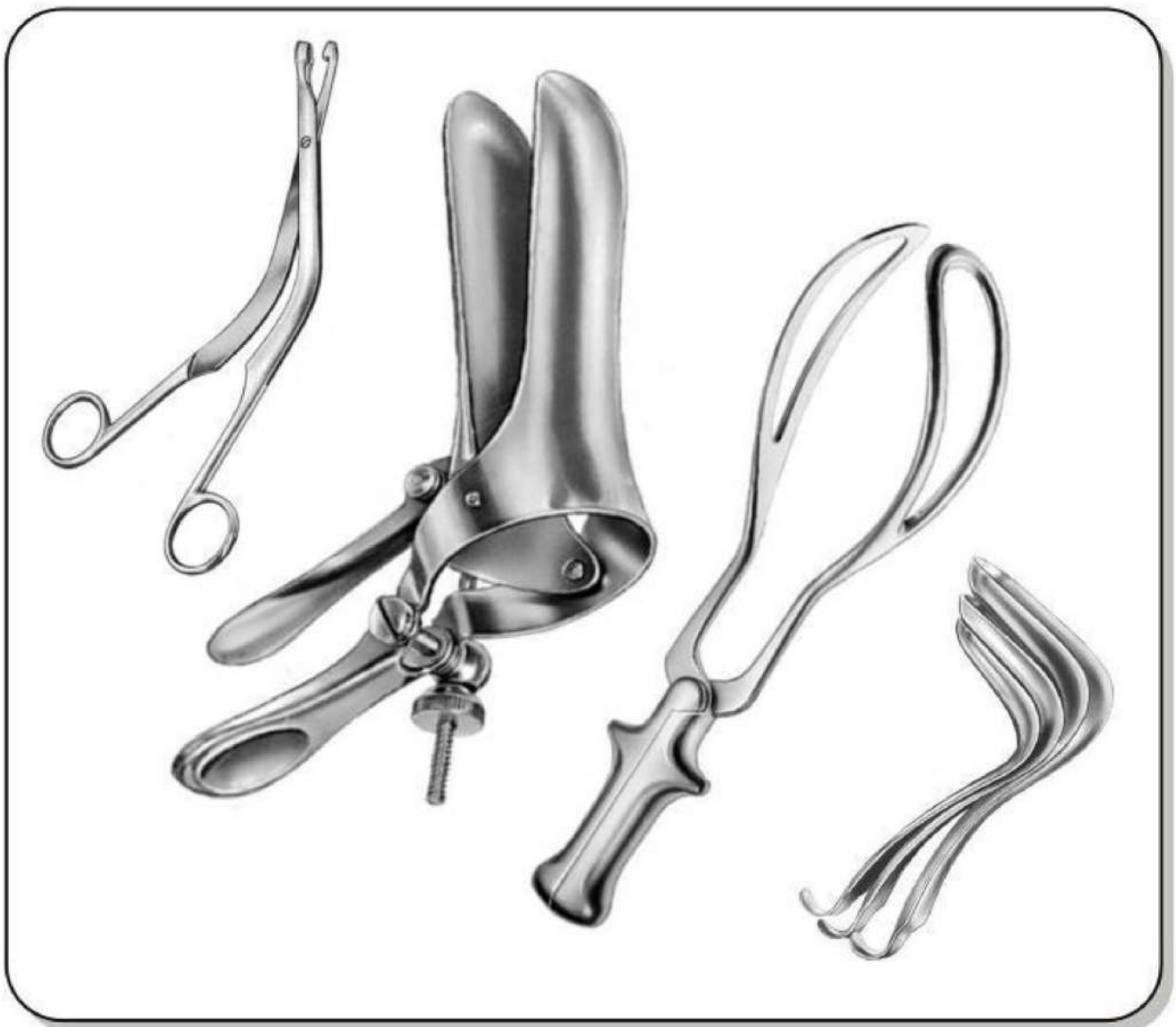



**TUFFRO**

The Mangalm Surgical Co.



**DE VILBISS**  
14-001-001  
4 x 27 cm  
102 mm x 32 mm  
Medium



**GRAVES**  
14-002-001  
75 x 20 mm  
Small  
14-003-002  
95 x 35 mm  
Medium  
14-004-003  
115 x 35 mm  
Large



**AUVARD**  
14-005-001  
Long Blade  
102 x 44 mm  
14-006-002  
Fixed Weight  
86 x 32 mm



**PEDERSON**  
14-007-001  
75 x 13 mm  
Small  
14-008-002  
100 x 22 mm  
Medium  
14-009-003  
120 x 25 mm  
Large



**CUSCO**  
14-010-001 75 x 32 mm  
14-011-002 85 x 35 mm  
14-012-003 100 x 35 mm



**CUSCO**  
14-013-004 75 x 18 mm



**CUSCO**  
14-014-001 80 x 22 mm  
14-015-002 100 x 25 mm  
14-016-003 105 x 27 mm



**TUFFRO**

The Mangalm Surgical Co.



**CUSCO**

- 14-017-001 75 x 34 mm
- 14-018-002 85 x 37 mm
- 14-019-003 100 x 37 mm



**COLLIN**

- 14-020-001 85 x 30 mm
- 14-021-002 100 x 35 mm
- 14-022-003 110 x 40 mm



**SEMM**

- 14-023-001 100 x 20 - 25 mm
- 14-024-002 105 x 27 - 3.5 mm



**CRAVE**

- 14-025-001 75 x 20 mm
- 14-026-002 95 x 35 mm
- 14-027-003 115 x 35 mm

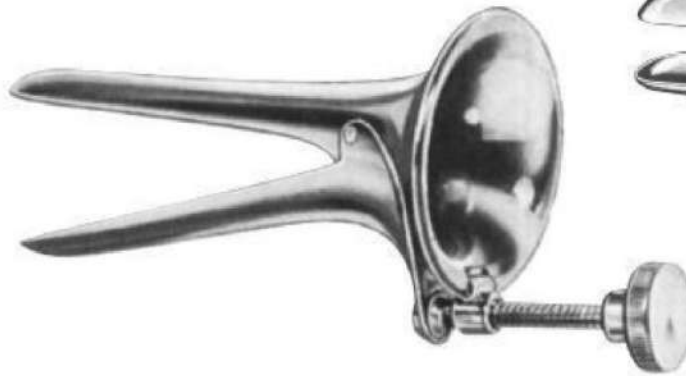

**COLLIN**

- 14-028-001 55 x 10 mm



**TRELAT**

- 14-029-001 85 mm 33 mm
- 14-030-002 95 mm 35 mm
- 14-031-003 115 mm 43 mm



**WINTERTON**  
14-032-001



**NOTT**

- 14-033-001 90 mm 30 mm
- 14-034-002 100 mm 30 mm



1/2

**SIMS**

- 14-035-001 65 x 25 / 70 x 30 mm
- 14-036-002 70 x 30 / 70 x 35 mm
- 14-037-003 85 x 35 / 90 x 40 mm



1/2

**KRISTELLER**

- 14-038-001 70 x 27 mm
- 14-039-002 80 x 30 mm
- 14-040-003 90 x 36 mm



1/2

**KRISTELLER**

- 14-041-001 75 x 23 mm
- 14-042-002 85 x 26 mm
- 14-043-003 100 x 32 mm



Slender Pattern

1/2

**KRISTELLER**

- 14-044-001 70 x 27 / 75 x 23 mm
- 14-045-002 80 x 30 / 85 x 26 mm
- 14-046-003 90 x 36 / 100 x 32 mm



Slender Pattern

1/2

**KRISTELLER**

- 14-047-001 105 x 18 mm
- 14-048-002 105 x 21 mm
- 14-049-001 110 x 14 mm
- 14-050-002 110 x 17 mm





Slender Pattern



**KRISTELLER**

- 14-051-001 105 x 18 mm / 110 x 14 mm
- 14-052-002 105 x 21 mm / 110 x 17 mm

Flat speculum

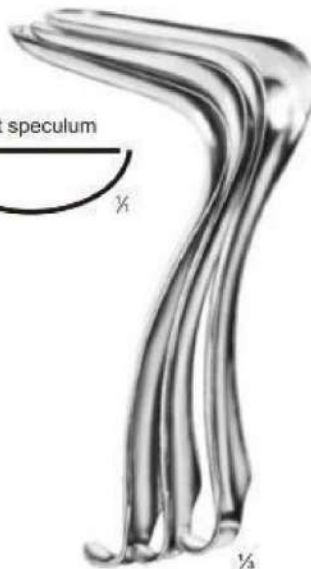

**KRISTELLER**

- 14-053-001 105 x 26 mm
- 14-054-002 105 x 28 mm
- 14-055-003 105 x 33 mm



**KRISTELLER**

- 14-056-001 115 x 22 mm
- 14-057-002 115 x 24 mm
- 14-058-003 115 x 29 mm

Flat speculum



**KRISTELLER**

- 14-059-001 105 x 26 mm / 115 x 22 mm
- 14-060-002 105 x 28 mm / 115 x 24 mm
- 14-061-003 105 x 33 mm / 115 x 29 mm

Deep speculum

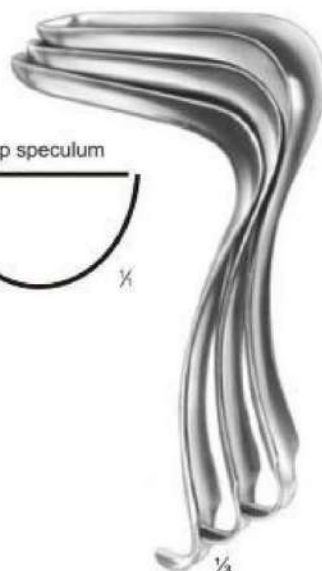

**KRISTELLER**

- 14-062-001 110 x 27 mm
- 14-063-002 110 x 30 mm
- 14-064-003 110 x 36 mm



**KRISTELLER**

- 14-065-001 115 x 23 mm
- 14-066-002 115 x 26 mm
- 14-067-003 115 x 32 mm



**TUFFRO**

The Mangalm Surgical Co.

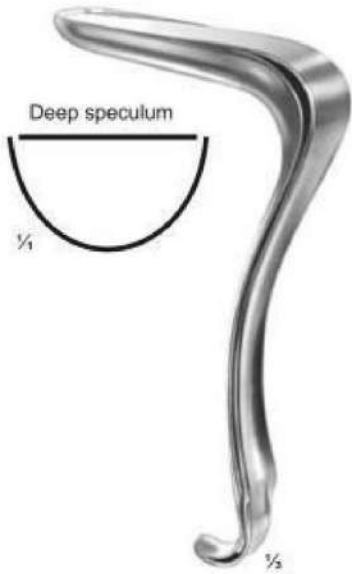

**KRISTELLER**

- 14-068-001 110 x 27 mm / 115 x 23 mm
- 14-069-002 110 x 30 mm / 115 x 26 mm
- 14-070-003 110 x 36 mm / 115 x 32 mm



**KALLMORGEN**

- 14-071-001 70 x 40 mm
- 14-072-002 90 x 40 mm



**KALLMORGEN**

- 14-073-001 70 x 33 mm
- 14-074-002 90 x 33 mm



**KALLMORGEN**

- 14-075-001 70 x 40 mm / 70 x 40 mm
- 14-076-002 90 x 40 mm / 90 x 33 mm

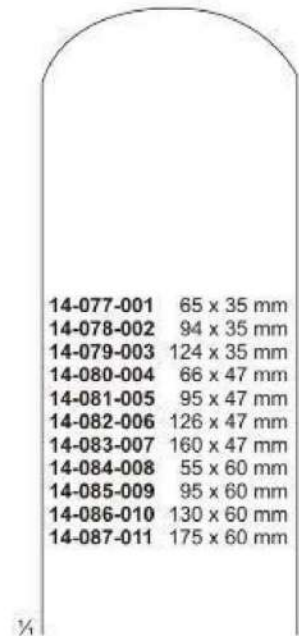

- 14-077-001 65 x 35 mm
- 14-078-002 94 x 35 mm
- 14-079-003 124 x 35 mm
- 14-080-004 66 x 47 mm
- 14-081-005 95 x 47 mm
- 14-082-006 126 x 47 mm
- 14-083-007 160 x 47 mm
- 14-084-008 55 x 60 mm
- 14-085-009 95 x 60 mm
- 14-086-010 130 x 60 mm
- 14-087-011 175 x 60 mm



**DOYEN VAGINAL SPECULUM**

- 14-088-220



**LANDON VAGINAL RETRACTOR**

- 14-089-090
- Blade 9 cm
- Deep 2.5 cm wide.



**GELPI VULVA RETRACTOR**

- 14-090-001
- self-retaining sharp hook jaws