



**TUFFRO**

The Mangalm Surgical Co.

**Neuro Spinal**



ADSON  
40.210.23  
23 cm/9"



ADSON  
40.213.23  
23 cm/9"

ADSON  
40.211.23  
23 cm/9"



LANDOLT  
40.875.22  
21,5 cm/8½"



HARDY  
40.876.21  
21 cm/8¼"



**TUFFRO**

The Mangalm Surgical Co.



1/2  
**TAYLOR**  
16 cm/6 1/4"

spitzes Ende  
pointed end  
pointe agudé  
punta aguda  
punta acuta

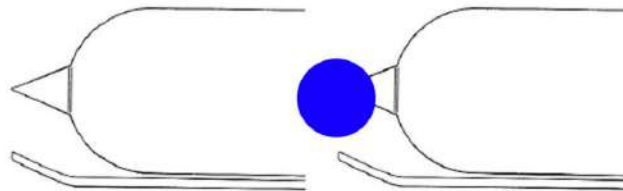

**32.831.16**  
75 x 30 mm

**32.833.16**  
100 x 30 mm

Knochenhebel  
Bone Levers  
Leviers à os  
Elevadores para hueso  
Elevatori per ossa

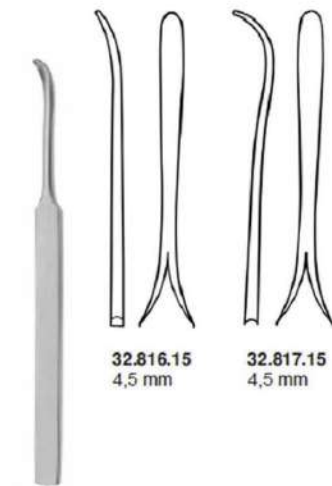

1/2  
**KOENIG**  
15 cm/6"

**32.816.15**  
4,5 mm

**32.817.15**  
4,5 mm

Sehnenfaßzange  
Tendon grasping forceps  
Pince pour saisir les tendons  
Pinza para agarrar tendones  
Pinze da presa per tendini



1/2  
**CARROL**  
**32.959.11**  
11 cm/4 1/2"

# Neuro Spinal



**TUFFRO**

The Mangalm Surgical Co.

**Neuro Spinal**



**33.210.95**  
Handbohrapparate allein  
Hand Drill only  
Perforateurs à main seul  
Perforadores de mano suelto  
Perforatori a mano solo

STILLE  
20,5 cm/8"

**33.210.20**  
Komplett mit 9 Bohrem/Fräsem  
complete with 9 twist drills/burrs  
complete avec 9 fraises  
completo con 9 brocas  
completo con 9 punte  
33.212.25 - 33.214.16



Spiralbohrer  
Twist Drill  
Mèche hélicoïdale  
Broca espiral  
Punta a spirale

**33.212.25**  
Ø 2,5 mm  
Fig. 1



Spiralbohrer  
Twist Drill  
Mèche hélicoïdale  
Broca espiral  
Punta a spirale

**33.212.30**  
Ø 3,0 mm  
Fig. 2



Spiralbohrer  
Twist Drill  
Mèche hélicoïdale  
Broca espiral  
Punta a spirale

**33.212.35**  
Ø 3,5 mm  
Fig. 3



Spiralbohrer  
Twist Drill  
Mèche hélicoïdale  
Broca espiral  
Punta a spirale

**33.212.40**  
Ø 4,0 mm  
Fig. 4



Komplett mit 3 Bohrem  
complete with 3 twist drills  
complete avec 3 fraises  
completo con 3 brocas  
completo con 3 punte  
33.212.25 - 33.212.35

STILLE SHERMAN  
**33.220.24**  
24 cm/9½"



Kugelfräser  
Spherical Burr  
Fraise spherique  
Fresa esf rica  
Fresa sferica

**33.214.05**  
Ø 5,0 mm  
Fig. 6



Kugelfräser  
Spherical Burr  
Fraise spherique  
Fresa esf rica  
Fresa sferica

**33.214.08**  
Ø 8,0 mm  
Fig. 7



Kugelfräser  
Spherical Burr  
Fraise spherique  
Fresa esf rica  
Fresa sferica

**33.214.12**  
Ø 12 mm  
Fig. 8



Kugelfräser  
Spherical Burr  
Fraise spherique  
Fresa esf rica  
Fresa sferica

**33.214.16**  
Ø 16 mm  
Fig. 9



Trepine  
Trépine  
Trépan  
Trapano

**33.214.10**  
Ø 10 mm  
Fig. 5



Spiralbohrer  
Twist Drill  
Mèche hélicoïdale  
Broca espiral  
Punta a spirale

**33.216.10**  
Ø 1,0 mm  
Fig. 10



Spiralbohrer  
Twist Drill  
Mèche hélicoïdale  
Broca espiral  
Punta a spirale

**33.216.15**  
Ø 1,5 mm  
Fig. 11



Spiralbohrer  
Twist Drill  
Mèche hélicoïdale  
Broca espiral  
Punta a spirale

**33.216.20**  
Ø 2,0 mm  
Fig. 12



**TUFFRO**

The Mangalm Surgical Co.

**Neuro Spinal**



**33.240.99**

Handbohrapparate allein  
Hand Drill only  
Perforateurs à main seul  
Perforadores de mano suelto  
Perforatori a mano solo

HUDSON  
27 cm/10 3/4"

**33.240.27**

komplett, mit Fräsem Fig. 1 - 4 33.242.09 - 33.242.22  
und Verlängerungsstück 33.246.00

complete, with burrs no. 1 - 4 33.242.09 - 33.242.22  
and extension piece 33.246.00

complet, avec fraises no. 1 - 4 33.242.09 - 33.242.22 et  
pièce de rallonge 33.246.00

completo, con fresas no. 1 - 4 33.242.09 - 33.242.22 y  
pieza de extensión 33.246.00

completo, con frese fig. 1 - 4 33.242.09 - 33.242.22 e  
giunto di prolungamento 33.246.00



Kegelfräser  
Conical Burr  
Fraise conique  
Fresa cónica  
Fresa cuneiforme

**33.242.09**  
Ø 9 mm  
Fig. 1



Kegelfräser  
Conical Burr  
Fraise conique  
Fresa cónica  
Fresa cuneiforme

**33.242.14**  
Ø 14 mm  
Fig. 2



Kugelfräser  
Spherical Burr  
Fraise spherique  
Fresa esférica  
Fresa sferica

**33.242.16**  
Ø 16 mm  
Fig. 3



Kugelfräser  
Spherical Burr  
Fraise spherique  
Fresa esférica  
Fresa sferica

**33.242.22**  
Ø 22 mm  
Fig. 4



Flachbohrer  
Flat Trephine  
Fraise plate  
Taladro plano  
Trapano piatto

CUSHING  
**33.244.14**  
Ø 14 mm  
Fig. 5



Spiralbohrer  
Twist Drill  
Mèche hélicoïdale  
Broca espiral  
Punta a spirale

**33.245.00**  
Ø 2,0 mm  
Fig. 6



Bohrer  
Burr  
Fraise  
Fresa  
Punta

MCKENZIE  
**33.248.00**  
Fig. 7



Bohrer  
Burr  
Fraise  
Fresa  
Punta

D'ERRICO  
**33.249.00**  
16 mm  
Fig. 8

Verlängerungsstück  
Extension piece  
Pièce de rallonge  
Pieza de prolongación  
Giunto di prolungamento



**33.246.00**



**33.246.01**



**TUFFRO**

The Mangalm Surgical Co.

**Neuro Spinal**

Hirnaht  
Brain Suture  
Sutura cerebral  
Suture cérébrale  
Sutura cerebrale



**McKENZIE**  
15 cm/6" 40.011.15  
19 cm/7½" 40.011.19



**McKENZIE**  
15 cm/6" 40.013.15  
19 cm/7½" 40.013.19



**SMITHWICK**  
23 cm/9" 40.015.23  
26 cm/10¼" 40.015.26



**SWEET**  
23 cm/9" 40.017.23  
26 cm/10¼" 40.017.26

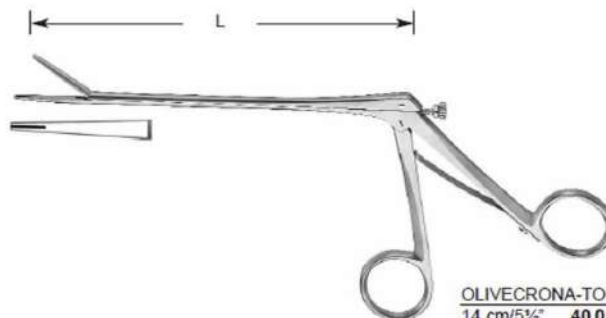

**OLIVECRONA-TOENNIS**  
14 cm/5½" 40.019.14  
20 cm/8" 40.019.20





**TUFFRO**

The Mangalm Surgical Co.



**McKENZIE**  
**40.020.00**  
148 x 40 x 6 mm

Klammernblock, mit 1 Klammernbügel  
Brain Clip Carrier, with 1 clip holding  
Support porte-agrafes, simple, à 1 rangée d'agrafes et couvercle à glissière  
Porta-grapas, con 1 reil para grapas  
Support metallico, semplice, con porta-fermagli e corperchio scorrevole



**McKENZIE**  
**40.020.02**  
190 x 48 x 13 mm

Klammernblock, mit 2 Klammernbügel  
Brain Clip Carrier, with 2 clip holding  
Support porte-agrafes, simple, à 2 rangées d'agrafes et couvercle à glissière  
Porta-grapas, con 2 reil para grapas  
Support metallico, semplice, con 2 porta-fermagli e corperchio scorrevole



**40.022.00**

Köln Spar Klammer, zu 100 Stück  
Köln clip reusable, comprising 100 pieces  
Cologne agrafe economica, Boîtes de 100 pièces  
grapa economica Colonia, conteniendo 100 piezas  
agrafe economica mod. Colonia, Unità di 100 pezzi



**RANEY**  
**40.027.00**

Kopfhautklammer  
Scalp Hemostasis Clip  
Agrafes hémostatique pour cuir chevelu  
Pinza hemostática para cuero cabelludo  
Clip emostatici per cuoio capelluto



**40.021.00**

Silberklammern in Plastikbehälter, zu 100 Stück  
Silver Brain Clips in plastic vial, comprising 100 pieces  
Agrafes en argent pur, Boîtes de 100 pièces  
Grapas de plata en tubo de plástico, conteniendo 100 piezas  
Fermagli d'argento, Unità di 100 pezzi



**RANEY**  
**40.028.00**  
15,5 cm/6¼"

Anlege-und Abnehme-Zange für Kopfhautklammern  
Applying and Removing Forceps for Scalp Hemostasis Clips  
Pine pour poser et retirer les clips hémostatiques du cuir chevelu  
Pinza para aplicar y quitar clips hemostáticas de cuero cabelludo  
Pinza per applicare o togliere i clip emostatici al cuoio capelluto

**Neuro Spinal**



**TUFFRO**

The Mangalm Surgical Co.

**Neuro Spinal**



**40.024.00**

großes Modell  
large pattern  
modèle grand  
modelo grande  
modello grande

175 mm



**40.024.10**

Ersatzdom  
Spare pin  
Pointe de rechange  
Espina de repuesto  
Punta di ricambio

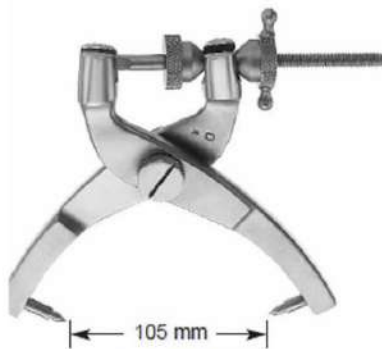

**CRUTCHFIELD  
40.025.01**

kleines Modell  
small pattern  
modèle petit  
modelo pequeño  
modello piccolo

105 mm



**CRUTCHFIELD  
40.025.02**

mittleres Modell  
medium pattern  
modèle moyen  
modelo mediano  
modello medio

155 mm



**CRUTCHFIELD  
40.026.35**  
7 cm/2 3/4"  
Ø 3,5 mm

Vorbohrer  
Drill Point  
Alésoir  
Perforador  
Alesatore



**CRUTCHFIELD  
40.026.50**  
7 cm/2 3/4"  
Ø 5,0 mm

Vorbohrer  
Drill Point  
Alésoir  
Perforador  
Alesatore



**TUFFRO**

The Mangalm Surgical Co.

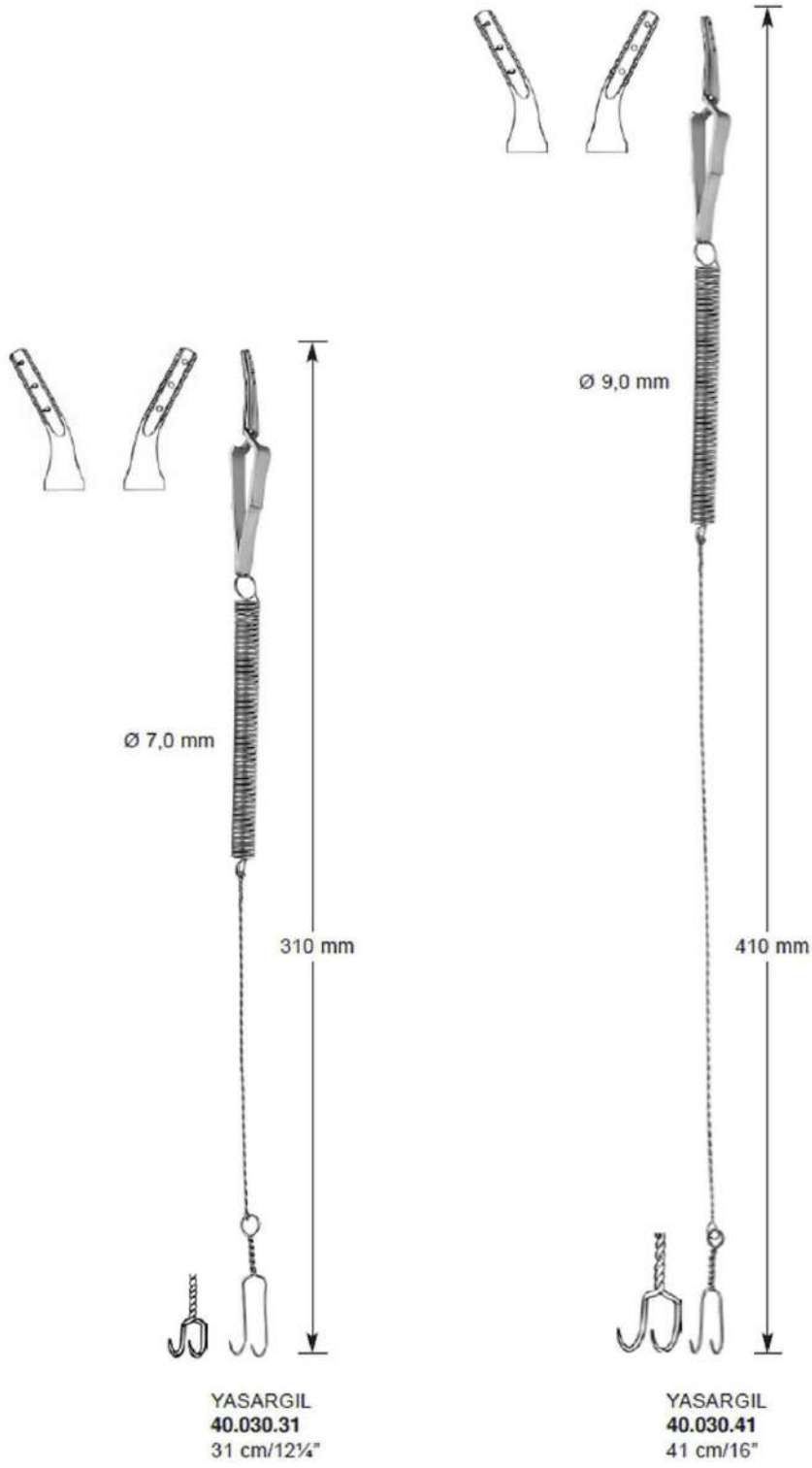

**Neuro Spinal**





**TUFFRO**

The Mangalm Surgical Co.

**Neuro Spinal**

Einführinstrument  
Wire Saw Guide  
Conducteur pour fils-scies  
Conductor para sierras de hilo  
Introduttore



De MARTEL  
40.090.33  
33 cm/13"



LEBSCHER  
40.091.25  
25 cm/10"

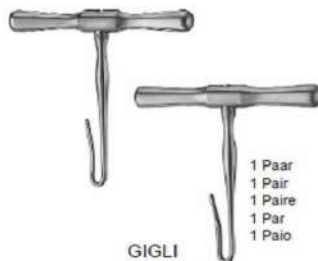

GIGLI  
40.094.00

1 Paar  
1 Pair  
1 Paire  
1 Par  
1 Paio



GIGLI  
40.094.01

1 Paar  
1 Pair  
1 Paire  
1 Par  
1 Paio

Drahtsägen-Handgriff  
Wire Saw Handle  
Manche à crochet  
Mango de gancho  
Manico con uncino

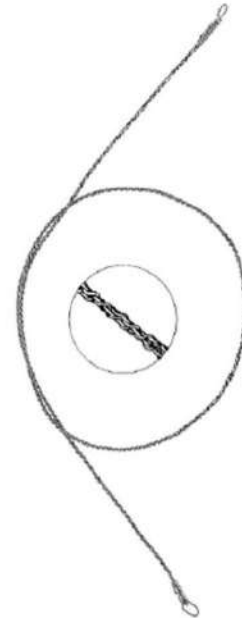

OLIVECRONA

23 cm/9"	40.092.22
30 cm/12"	40.092.30
40 cm/16"	40.092.40
50 cm/20"	40.092.50
60 cm/24"	40.092.60
70 cm/28"	40.092.70
75 cm/30"	40.092.75

2 x

GIGLI

25 cm/10"	40.093.25
30 cm/12"	40.093.30
40 cm/16"	40.093.40
50 cm/20"	40.093.50
60 cm/24"	40.093.60
70 cm/28"	40.093.70

3 x

OLIVECRONA-GIGLI

30 cm/12"	40.094.30
40 cm/16"	40.094.40
50 cm/20"	40.094.50
60 cm/24"	40.094.60
70 cm/28"	40.094.70

4 x



**TUFFRO**

The Mangalm Surgical Co.

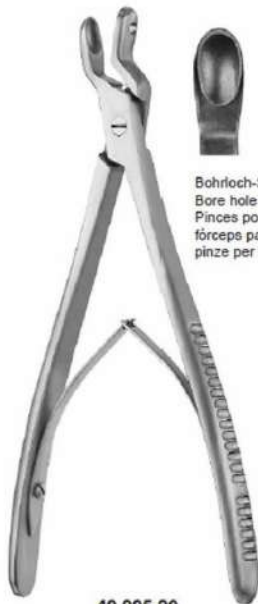

**40.095.20**  
20,5 cm/8"

Bohrloch-Schutzzange  
Bore hole protection forceps  
Pinces pour protéger alésage  
fórceps para la protección de orificio  
pinze per la protezione di foro



CONE

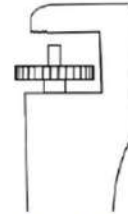

**40.098.20**  
20 cm/8"

bis 7 mm Schädelstärke  
for skull thickness up to 7 mm  
pour épaisseur de la boîte crânienne jusqu'à 7 mm  
hasta 7 mm de espesor de la pared craneal  
per spessore cranico fino a mm. 7

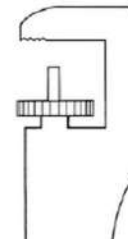

**40.098.23**  
23 cm/9"

bis 12 mm Schädelstärke  
for skull thickness up to 12 mm  
pour épaisseur de la boîte crânienne jusqu'à 12 mm  
hasta 12 mm de espesor de la pared craneal  
per spessore cranico fino a mm. 12



DeVILBISS  
**40.096.21**  
21 cm/8¼"

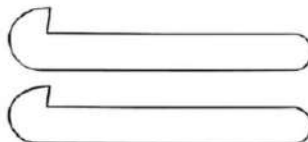

komplett mit je 1 kleinen und 1 großen Blatt  
complete with 1 small and 1 large blade  
complète avec 1 petit et 1 grand crochet  
completa con 1 gancho pequeño y 1 gancho grande  
completa di 1 uncino piccolo ed 1 uncino grande



DAHLGREN  
**40.097.20**  
21 cm/8¼"



komplett mit 2 Reserveblättern  
complete with 2 spare blades  
complète avec 2 crochets de rechange  
completa con 2 ganchos de repuesto  
completa di 2 Uncini di ricambio

**Neuro Spinal**



**TUFFRO**

The Mangalm Surgical Co.

**Neuro Spinal**

Dura - und Hauthäkchen  
Dura and skin hooks  
Crochets à dure-mère, Crochets dermatologiques  
Ganchitos para dura-madre y piel  
Uncini per dura madre, Uncini per la pelle

**SURGICAL INSTRUMENTS**



**CAIRNS**  
18.206.13  
13 cm/5"

spitz  
sharp  
pointue  
aguda  
acuta



**LAHEY**  
18.213.13  
13 cm/5"



**CUSHING**  
18.213.14  
14 cm/5½"



**FRAZIER**

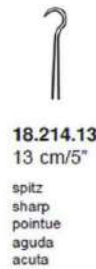

**18.214.13**  
13 cm/5"  
spitz  
sharp  
pointue  
aguda  
acuta

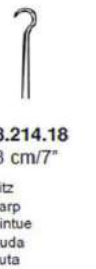

**18.214.18**  
18 cm/7"  
spitz  
sharp  
pointue  
aguda  
acuta



**18.215.13**  
13 cm/5"  
stumpf  
blunt  
mousse  
romo  
smusso



**18.215.18**  
18 cm/7"  
stumpf  
blunt  
mousse  
romo  
smusso



**JOSEPH**  
18.216.01  
16 cm/6¼"

spitz  
sharp  
pointue  
aguda  
acuta



**JOSEPH**  
16 cm/6¼"



**18.216.02**  
2 mm



**18.216.05**  
5 mm

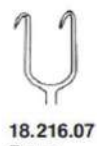

**18.216.07**  
7 mm



**18.216.10**  
10 mm

spitz  
sharp  
pointue  
aguda  
acuta



**FREER**  
18.218.15  
15 cm/6"

spitz  
sharp  
pointue  
aguda  
acuta



**TOENNIS**  
18.219.15  
15 cm/6"

spitz  
sharp  
pointue  
aguda  
acuta



**TUFFRO**

The Mangalm Surgical Co.

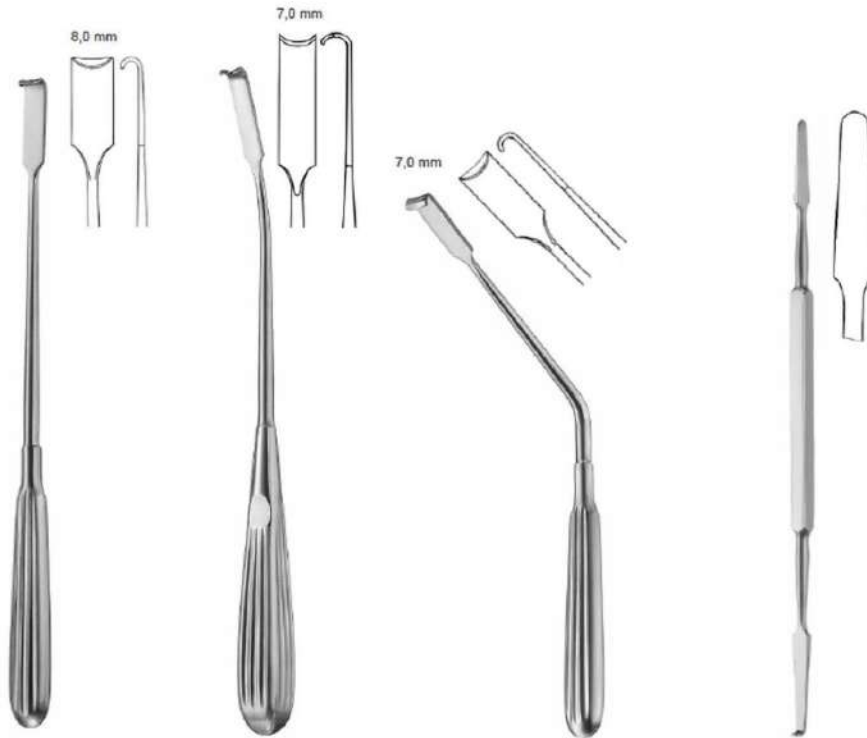

SCOVILLE  
40.044.23  
23 cm/9"

HOLSCHER  
40.045.24  
24 cm/9½"

SCOVILLE  
40.048.19  
19 cm/7½"

O'CONNELL  
40.046.22  
22 cm/8¾"



40.049.21  
21 cm/8¼"



links  
left  
à gauche  
à la izquierda  
sinistra

DANDY  
40.051.20  
20 cm/8"



DANDY  
40.052.20  
20 cm/8"



rechts  
right  
à droite  
à la derecha  
destra

DANDY  
40.053.20  
20 cm/8"

# Neuro Spinal



**TUFFRO**

The Mangalm Surgical Co.

**Neuro Spinal**



**CRILE**  
40.054.20  
20 cm/8"  
Fig. 1



**CUSHING**

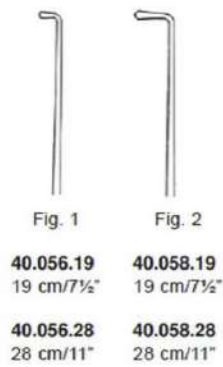

Fig. 1      Fig. 2  
40.056.19    40.058.19  
19 cm/7½"   19 cm/7½"  
40.056.28    40.058.28  
28 cm/11"    28 cm/11"



**HOEN**  
40.060.23  
23 cm/9"



**GRAHAM**  
40.061.16  
16,5 cm/6½"



**SACHS**  
40.064.18  
18,5 cm/7¼"

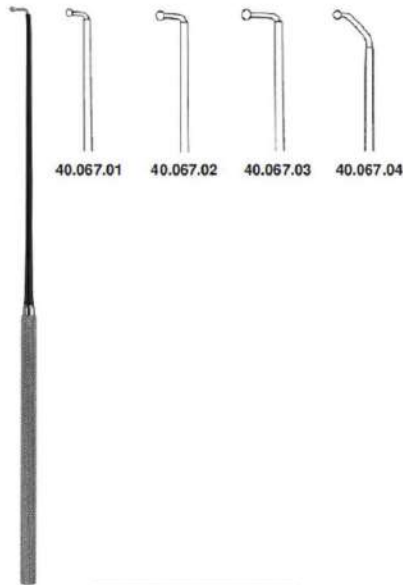

**CASPAR**  
24,5 cm/9¾"

**CASPAR (CCR)** 132 - 136  
179 - 184  
Siehe auch Seite: 199  
See also page: 212  
Voir aussi la page: 228  
Véase también la página: 228  
Vedere anche pagina: 230



**ADSON**  
20 cm/8"



**GRONINGEN**  
26,5 cm/10½"

stumpf  
blunt  
mousse  
romo  
smusso

stumpf  
blunt  
mousse  
romo  
smusso

spitz  
sharp  
pointue  
aguda  
acuta

spitz  
sharp  
pointue  
aguda  
acuta

stumpf  
blunt  
mousse  
romo  
smusso





**TUFFRO**

The Mangalm Surgical Co.



**40.070.17**  
17 cm/6¾"

**40.070.21**  
21 cm/8¼"

SMITHWICK



SMITHWICK  
**40.070.29**  
29 cm/11½"



SCOVILLE  
**40.070.30**  
30 cm/12"



SCOVILLE  
**40.071.30**  
30 cm/12"

# Neuro Spinal



LOVE  
40.071.21  
21 cm/8 1/4"



CASPAR  
24 cm/9 1/2"  
6 mm 40.072.06  
8 mm 40.072.08  
10 mm 40.072.10



HESS (LOVE modif.)  
17,5 cm/7"

CASPAR (CCR)	132 - 136
	179 - 184
Siehe auch Seite:	199
See also page:	212
Voir aussi la page:	228
Véase también la página:	230
Vedre anche pagina:	230

Aneurysmen-Nadel  
Aneurysm needle  
Aiguille à aneurysme  
Aguja para aneurisma  
Ago da aneurisma



ADSON  
40.078.22  
22 cm/8 3/4"  
2 mm



LOVE  
40.080.19  
19 cm/7 1/2"



LOVE  
40.081.19  
19 cm/7 1/2"



LOVE  
40.083.19  
19 cm/7 1/2"



**TUFFRO**

The Mangalm Surgical Co.

Knochendeckel-Elevatorium  
Bone flap elevator  
Rugines-Raspatoires pour lambeau osseux  
Periostótomos para hueso solapa  
Periostotomi per lembo osseo



**40.102.17**  
17,5 cm/7"



3,2 mm  
4,6 mm  
**40.132.01**   **40.132.02**

**PARTSCH**  
15 cm/6"



4 mm  
**LANGE**  
**40.132.14**  
14,5 cm/5 3/4"

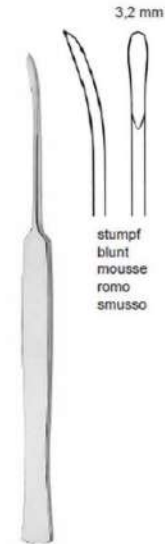

3,2 mm  
**LEMPERT**  
**40.133.16**  
16,5 cm/6 1/2"

stumpf  
blunt  
mousse  
romo  
smusso



6,3 mm  
**LEMPERT**  
**40.134.18**  
18,5 cm/7 1/4"

halbscharf  
semi-sharp  
semitranchante  
semi agudo  
semiacuto

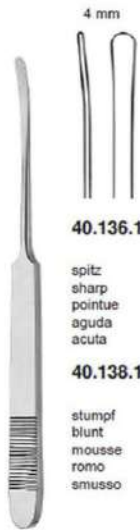

4 mm  
**40.136.16**

**40.138.16**

stumpf  
blunt  
mousse  
romo  
smusso

**ST CLAIR THOMPSON**  
16 cm/6 1/4"



**HALLE**  
**40.139.16**  
16 cm/6 1/4"  
3,5 mm



3 mm  
**SUNDAY**  
**40.140.23**  
23 cm/9"

stumpf  
blunt  
mousse  
romo  
smusso

**Neuro Spinal**



**TUFFRO**

The Mangalm Surgical Co.

**Neuro Spinal**



**TOENNIS**  
25 cm/10"

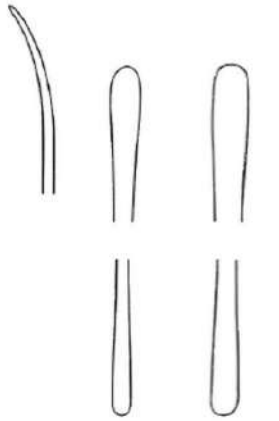

**40.141.25 40.142.25**  
Fig. 1 Fig. 2

Duradissektoren  
Dura Dissectors  
Dissecteurs à dure-mère  
Disecadores para duramadre  
Dissettori per la dura-madre



**SACHS**  
**40.143.21**  
21 cm/8 1/4"

spitz  
sharp  
pointue  
aguda  
acuta



**SACHS**  
**40.145.21**  
21 cm/8 1/4"

spitz  
sharp  
pointue  
aguda  
acuta



**MILLIGAN**  
**40.147.21**  
21 cm/8 1/4"

Sonde und Dissektor  
Probe dissector  
Sonde et dissecteur  
Sonda y disecador  
sonda e dissetto



**MILLIGAN**  
**40.149.22**  
22 cm/8 3/4"



**PENNYBAKER**  
**40.149.23**  
23 cm/9"



**DAVIS**  
**40.151.24**  
24,5 cm/9 3/4"

Dura-Elevatoren  
Dura separators  
Separateurs per dure-mère  
Separadores para duramadre  
Elevatori per la dura-madre

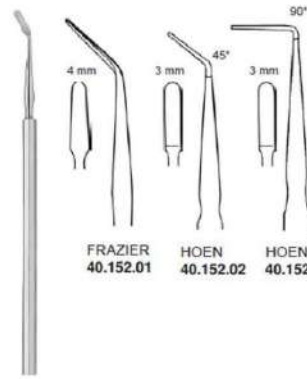

**FRAZIER**  
**40.152.01**

**HOEN**  
**40.152.02**

**HOEN**  
**40.152.03**

15 cm/6"



**TUFFRO**

The Mangalm Surgical Co.



**HORSLEY**  
**40.155.20**  
20 cm/8"



**SACHS**  
**40.157.21**  
21 cm/8 1/4"

Dissektor mit flexiblem Schaft  
Dissector with flexible shaft  
Dissecteur à arbre flexible  
Dissector con eje flexible  
Dissector con asta flessibile



**40.157.19**  
4 mm

für Kinder  
for children  
pour les enfants  
para los niños  
per i bambini

**40.159.19**  
7 mm

für Erwachsene  
for adults  
pour les adultes  
para adultos  
per adulti

**YASARGIL**  
19,5 cm/7 3/4"



**PENFIELD**  
**40.161.01**  
17,5 cm/7"  
Fig. 1



**PENFIELD**  
**40.161.02**  
19,5 cm/7 3/4"  
Fig. 2



**PENFIELD**  
**40.161.03**  
19,5 cm/7 3/4"  
Fig. 3



**PENFIELD**  
**40.161.04**  
20,5 cm/8"  
Fig. 4



**PENFIELD**  
**40.161.05**  
18,5 cm/7 1/4"  
Fig. 5

**Neuro Spinal**





**TUFFRO**

The Mangalm Surgical Co.

**Neuro Spinal**



**40.162.29**  
29 cm/11½"

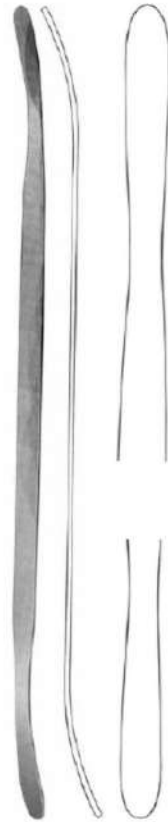

**40.163.29**  
29 cm/11½"

Trigeminal knife  
Couteau pour trigémeau  
Cuchillo para trigémino  
Cottello per trigemino

Duramesser  
Dura knife  
Couteau pour dure-mère  
Cuchillo para duramadre  
Cottello per la dura-madre

Chordotome  
Cordotome  
Cordotomes  
Cordotomi  
Cordotomi



**FRAZIER**  
**40.167.18**  
18 cm/7"



**40.167.23**  
23 cm/9"

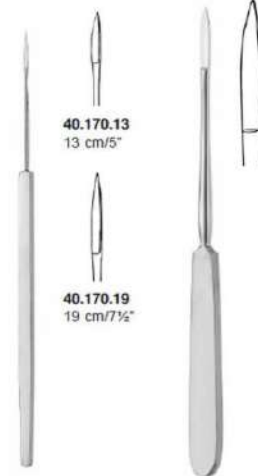

**40.170.13**  
13 cm/5"

**40.170.19**  
19 cm/7½"

**TOENNIS**

**HALLE**  
**40.170.20**  
20 cm/8"



**TUFFRO**

The Mangalm Surgical Co.

Nerv- und Gefäßhäkchen  
Nerve and vessel hooks  
Crochets à nerfs et à vaisseaux  
Ganchos para nervios y vasos  
Uncini per nervi e vasi



**KRAYENBÜHL**  
**40.065.01**  
Fig. 1



**KRAYENBÜHL**  
**40.065.02**  
Fig. 2



**KRAYENBÜHL**  
**40.065.03**  
Fig. 3



**KRAYENBÜHL**  
**40.065.04**  
Fig. 4

Fadenführer, geknüpft  
Ligature Guides and Carriers, probe pointed  
Passe-fils  
Guia-ligadura, abotonado  
Guide per legatura



**YASARGIL**  
**40.064.01**  
Fig. 1



**YASARGIL**  
**40.064.02**  
Fig. 2



**YASARGIL**  
**40.064.03**  
Fig. 3



**YASARGIL**  
**40.064.04**  
Fig. 4

18,5 cm/7¼"

Gefäß Messer  
Vessel knife  
Couteau pour vaisseaux  
Cuchillo para vasos  
Coltello per vasi



18,5 cm/7¼"



**KOOS**  
**40.065.51**

aufgebogen  
upwards curved  
courbe vers le haut  
curva hacia arriba  
curvo in sú



**KOOS**  
**40.065.52**

abgebogen  
downward curved  
courbe vers le bas  
curva hacia abajo  
curvo in giù



**KOOS**  
**40.065.53**

aufgebogen  
upwards curved  
courbe vers le haut  
curva hacia arriba  
curvo in sú



**KOOS**  
**40.065.54**

abgebogen  
downward curved  
courbe vers le bas  
curva hacia abajo  
curvo in giù



**KOOS**  
**40.065.57**

aufgebogen  
upwards curved  
courbe vers le haut  
curva hacia arriba  
curvo in sú



**KOOS**  
**40.065.56**

abgebogen  
downward curved  
courbe vers le bas  
curva hacia abajo  
curvo in giù

Arachnoidea Messer  
Arachnoid knife  
Couteaux arachnoidiens  
Arachnoidea cuchillos  
Arachnoidea coltelli



**YASARGIL**  
**40.065.65**

abgebogen  
downward curved  
courbe vers le bas  
curva hacia abajo  
curvo in giù



**YASARGIL**  
**40.065.66**

aufgebogen  
upwards curved  
courbe vers le haut  
curva hacia arriba  
curvo in sú

**Neuro Spinal**



**TUFFRO**

The Mangalm Surgical Co.

**Neuro Spinal**



**YASARGIL**  
19 cm/7½"



**40.066.01**



**40.066.02**



**40.066.03**



**40.066.04**



Gefäßspreizer  
Vessel Spreader  
Ecarteur pour vaisseaux  
Separador para vasos  
Divaricatore per vasi

**BIEMER**  
**40.066.10**  
16 cm/6¼"

Ø 0,5 mm



**40.066.16**  
12,5 cm/5"

Ø 1,0 mm



**40.066.17**  
12,5 cm/5"

Ø 1,5 mm



**40.066.18**  
12,5 cm/5"

Gefäßdilator  
Vessel Dilator  
Dilateurs vasculaires  
Dilatadores vasculares  
Dilattori vascolari



**JACOBSON**  
**40.066.19**  
18,5 cm/7¼"



**JACOBSON**  
**40.066.20**  
18,5 cm/7¼"

Knopfsonde  
Buttoned probes  
Sondes boutonées  
Sondas abotonadas  
Sonde bottonute



**TUFFRO**

The Mangalm Surgical Co.



SAMII  
23 cm/9"

Tumormesser  
Tumor knives  
Couteaux à tumeurs  
Cuchillos para tumores  
Coltelli per tumori



40.075.10 1,0 mm  
40.075.11 1,5 mm



40.075.12 2,0 mm  
40.075.13 2,5 mm



40.075.14 3,0 mm  
40.075.15 3,5 mm

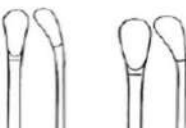

40.075.16 4,0 mm  
40.075.18 5,0 mm

Messer für Tumorgewebe  
Knives for tumor tissue  
Couteaux pour tissu de tumeur  
Cuchillos para tejidos con tumores  
Coltelli per tessuto tumorale

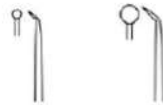

40.076.01 1,5 mm  
40.076.02 3,0 mm

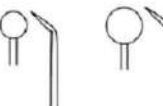

40.076.03 4,5 mm  
40.076.04 6,0 mm

Lanzettenmesser für Tumorgewebe  
Lancet knives for tumor tissue  
Couteaux lancéolaires pour tissu de tumeur  
Cuchillos en forma de lanceta para tejidos con tumores  
Coltelli lanceolato per tessuto tumorale

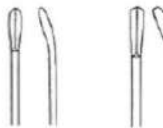

40.077.18 1,8 mm  
40.077.25 2,5 mm

Tumorgabeln  
Tumor forks  
Fourches à tumeurs  
Horquillas para tumores  
Forchette per tumori

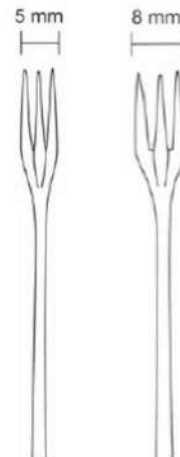

40.079.05 5 mm  
40.079.08 8 mm



YASARGIL  
20 cm/8"

**Neuro Spinal**



**TUFFRO**

The Mangalm Surgical Co.

**Neuro Spinal**

Disektoren  
Dissectors  
Dissecteurs  
Dissectores  
Dissettori



CASPAR  
244



**40.171.01**  
23 cm/9"  
4,5 mm



**40.171.02**  
23 cm/9"  
4,5 mm



**40.171.03**  
23 cm/9"  
2 mm



**40.173.01**  
20 cm/8"  
1 mm



**40.173.02**  
21 cm/8¼"  
1 mm



**40.173.03**  
21 cm/8¼"  
1 mm





**TUFFRO**

The Mangalm Surgical Co.



biegsam  
malleable  
malléable  
maleable  
malleabile

**CUSHING**

<b>40.250.07</b>	7/9 x 180 mm
<b>40.250.11</b>	11/13 x 180 mm
<b>40.250.15</b>	15/18 x 180 mm
<b>40.250.18</b>	18/22 x 180 mm



konvex  
convex  
convexe  
convexa  
convessa

**OLIVECRONA**

<b>40.252.13</b>	7/9 x 180 mm
<b>40.252.15</b>	11/13 x 180 mm
<b>40.252.17</b>	15/18 x 180 mm
<b>40.252.19</b>	18/22 x 180 mm



konkav  
concave  
concave  
côncava  
concava

**OLIVECRONA**

<b>40.253.07</b>	7/9 x 180 mm
<b>40.253.11</b>	11/13 x 180 mm
<b>40.253.15</b>	15/18 x 180 mm
<b>40.253.18</b>	18/22 x 180 mm



biegsam  
malleable  
malléable  
maleable  
malleabile

**SCOVILLE**

<b>40.254.10</b>	10/13 x 200 mm
<b>40.254.16</b>	16/19 x 200 mm



biegsam  
malleable  
malléable  
maleable  
malleabile

**AACHEN**

<b>40.256.07</b>	7/8 x 200 mm
<b>40.256.10</b>	10/11 x 200 mm
<b>40.256.13</b>	13/14 x 200 mm
<b>40.256.16</b>	16/17 x 200 mm
<b>40.256.19</b>	19/20 x 200 mm
<b>40.256.22</b>	22/25 x 200 mm



biegsam  
malleable  
malléable  
maleable  
malleabile

<b>40.257.01</b>	9 x 200 mm
<b>40.257.02</b>	12 x 200 mm
<b>40.257.03</b>	12 x 250 mm

**Neuro Spinal**



**TUFFRO**

The Mangalm Surgical Co.

**Neuro Spinal**



CAIRNS	
40.258.06	6 x 200 mm
40.258.08	8 x 200 mm
40.258.10	10 x 200 mm
40.258.11	11 x 200 mm
40.258.13	13 x 200 mm
40.258.16	16 x 200 mm
40.258.19	19 x 200 mm
40.258.25	25 x 200 mm

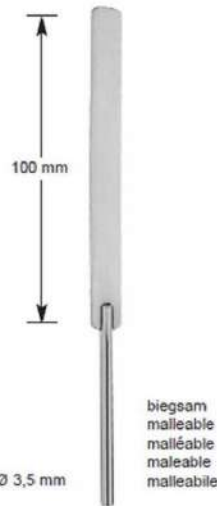

HEIFETZ	
40.259.08	8 x 155 mm
40.259.11	11 x 155 mm
40.259.14	14 x 155 mm
40.259.17	17 x 155 mm

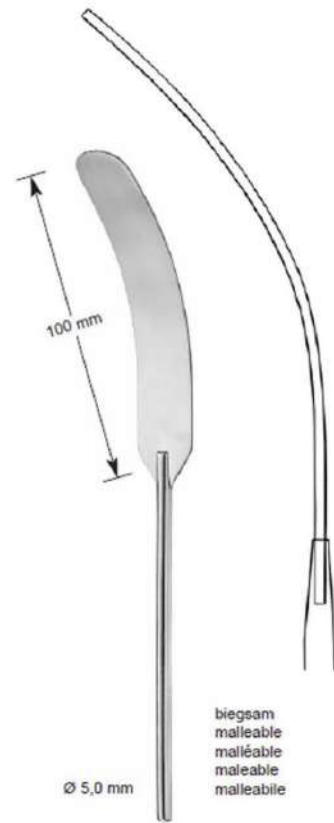

HEIFETZ	
40.260.08	8 x 200 mm
40.260.11	11 x 200 mm
40.260.14	14 x 200 mm
40.260.17	17 x 200 mm
40.260.20	20 x 200 mm



**TUFFRO**

The Mangalm Surgical Co.

Nutzlänge  
working length  
longueur utile  
largo útil  
lunghezza utile

	ø 1,5 mm 4 - 5 Charr.	ø 2,0 mm 6 Charr.	ø 2,5 mm 7 - 8 Charr.	ø 3,5 mm 13 - 14 Charr.	ø 4,5 mm 16 - 17 Charr.
13 cm/5"	40.286.13	40.287.13	40.288.13	40.289.13	
15 cm/6"	40.286.15	40.287.15	40.288.15	40.289.15	
18 cm/7"	40.286.18	40.287.18	40.288.18	40.289.18	40.289.45
22 cm/8 3/4"	40.286.22	40.287.22	40.288.22	40.289.22	

Schlaucholive ø 6,5 - 9 mm  
Olive ø 6,5 - 9 mm  
Oliva ø 6,5 - 9 mm  
Oliva ø 6,5 - 9 mm

LUER

YASARGIL

mit zentraler Bohrung  
with central bore  
avec trou central  
con un foro centrale  
con un agujero central

04.148.27  
ø 2,0 mm

04.149.27  
ø 4,8 mm

YANKAUER  
28,5 cm/11 1/4"

Saugkanülen mit Unterbrecher und Mandrin  
Suction Cannulae with finger cut-off and stylet  
Canules d'aspiration avec interrupteur à doigt  
Cánulas para aspiración con interruptor y estileto  
Cannule per aspirazione con interruttore e stiletto

04.155.30  
ø 3,0 mm  
Fig. 1

04.155.35  
ø 3,5 mm  
Fig. 2

04.155.40  
ø 4,0 mm  
Fig. 3

04.155.99  
Mandrin  
Stylet  
Doigt  
Esfileto  
Stiletto

MAGILL  
24,5 cm/9 3/4"

ADSON  
40.290.16  
16,5 cm/6 1/2"  
ø 3 mm

ADSON  
40.290.21  
21 cm/8 1/4"  
ø 4 mm

FRAZIER  
40.290.24  
24 cm/9 1/2"  
ø 3,3 mm

FRAZIER  
40.292.08  
ø 2,7 mm/ 8 charr.

12 cm/4 3/4"

**Neuro Spinal**



**TUFFRO**

The Mangalm Surgical Co.

**Neuro Spinal**



Schlaucholive ø 7 - 9 mm  
 Olive ø 7 - 9 mm  
 Olive ø 7 - 9 mm  
 Oliva ø 7 - 9 mm  
 Oliva ø 7 - 9 mm

1/2  
**LEMPERT**  
 20 cm/8"

ø 2 mm	40.283.02
ø 3 mm	40.283.03

Ø mm	F.G. Charr.	11 cm/4 1/4"	13 cm/5"	16 cm/6 1/4"	20 cm/8"
ø 1,5 mm	4 - 5	40.270.15	40.271.15	40.272.15	40.273.15
ø 2,0 mm	6	40.270.20	40.271.20	40.272.20	40.273.20
ø 2,5 mm	7 - 8	40.270.25	40.271.25	40.272.25	40.273.25
ø 3,0 mm	9	40.270.30	40.271.30	40.272.30	40.273.30
ø 4,0 mm	12	40.270.40	40.271.40	40.272.40	40.273.40
ø 5,0 mm	15	40.270.50	40.271.50	40.272.50	40.273.50

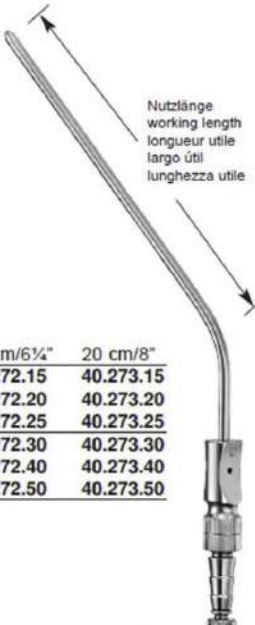

Nutzlänge  
 working length  
 longueur utile  
 largo útil  
 lunghezza utile

1/2  
**FERGISSON**



isoliert  
 insulated  
 isolée  
 aislados  
 isolato

Schlaucholive ø 6 - 9 mm  
 Olive ø 6 - 9 mm  
 Olive ø 6 - 9 mm  
 Oliva ø 6 - 9 mm  
 Oliva ø 6 - 9 mm

1/2  
**FERGISSON**  
 40.291.04  
 18 cm/7"  
 ø 4 mm

Saugkanülen mit Unterbrecher und Mandrin  
 Suction Cannulae with finger out-off and stylet  
 Canules d'aspiration avec interrupteur à doigt  
 Cánulas para aspiración con interruptor y estilete  
 Cannule per aspirazione con interruttore e stiletto

F.G. Charr.	Ø mm	30°	75°
6	2,0	40.295.06	40.297.06
7	2,3	40.295.07	40.297.07
8	2,7	40.295.08	40.297.08
9	3,0	40.295.09	40.297.09
10	3,3	40.295.10	40.297.10
11	3,7	40.295.11	40.297.11
12	4,0	40.295.12	40.297.12
15	5,0	40.295.15	40.297.15



1/2  
**FRAZIER**  
 19 cm/7 1/2"



**FRAZIER**

6 Charr.	40.293.06
8 Charr.	40.293.08
9 Charr.	40.293.09
10 Charr.	40.293.10
12 Charr.	40.293.12



**FRAZIER**

F.G. Charr.	ø mm	12,5 cm/5"	18 cm/7"
6	2,0	40.296.06	40.296.16
8	2,7	40.296.08	40.296.18
10	3,3	40.296.10	40.296.30
12	4,0	40.296.12	40.296.32



**FRAZIER**

	19 cm/7½"
7 charr.	40.299.07
9 charr.	40.299.09
11 charr.	40.299.11

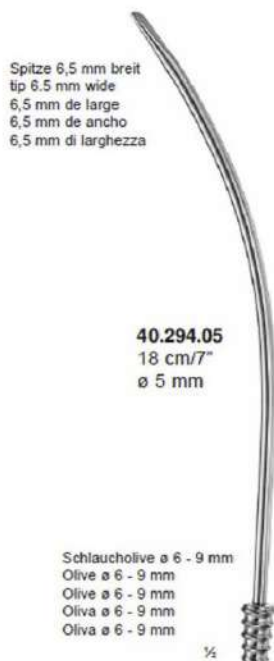

ø 4,5 mm	40.307.45
ø 5,5 mm	40.307.55



4-5 charr.	ø 1,5 mm	40.313.15
6 charr.	ø 2,0 mm	40.313.20
7-8 charr.	ø 2,5 mm	40.313.25
9 charr.	ø 3,0 mm	40.313.30

Schlaucholive ø 6 - 9 mm  
Olive ø 6 - 9 mm  
Olive ø 6 - 9 mm  
Oliva ø 6 - 9 mm  
Oliva ø 6 - 9 mm

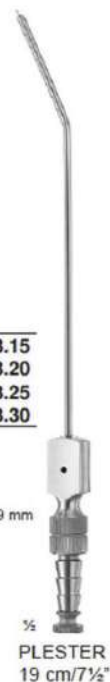

# Neuro Spinal





**TUFFRO**

The Mangalm Surgical Co.

**Neuro Spinal**



**FRAZIER**  
12 cm/4 3/4"

ø 2,0 mm	40.298.08
ø 2,5 mm	40.298.10
ø 3,0 mm	40.298.12



ø 2,0 mm	40.300.20
ø 2,5 mm	40.300.25



**CONE**  
9 cm/3 1/2"

12 G.	Ø 2,64 mm	40.302.12
13 G.	Ø 2,24 mm	40.302.13
14 G.	Ø 2,03 mm	40.302.14
15 G.	Ø 1,83 mm	40.302.15
16 G.	Ø 1,62 mm	40.302.16
17 G.	Ø 1,42 mm	40.302.17
18 G.	Ø 1,22 mm	40.302.18
20 G.	Ø 0,91 mm	40.302.20



**JEFFERSON**

8 cm/3 1/4"	40.301.08
10 cm/4"	40.301.10



**DANDY**

ø 2,0 mm	40.303.20
----------	-----------

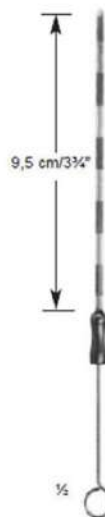

**CUSHING-CAIRNS**

ø 2,3 mm	40.304.23
ø 2,6 mm	40.304.26



**TUFFRO**

The Mangalm Surgical Co.



**BECK**  
40.413.02



**PENNYBACKER**  
40.423.03

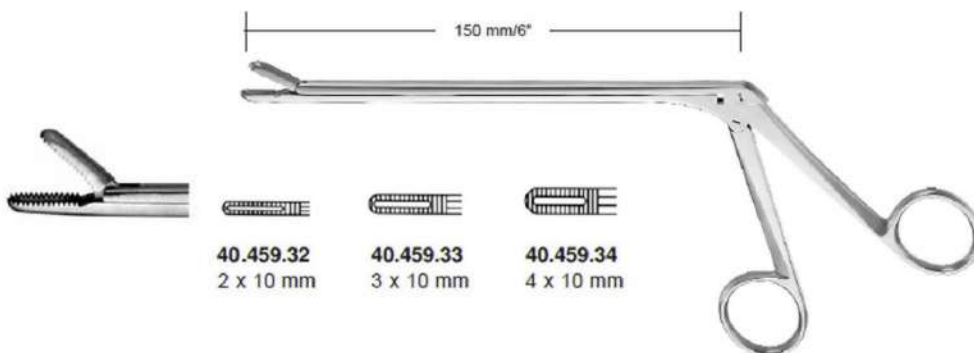

**SCHLESINGER**

**Neuro Spinal**



**TUFFRO**

The Mangalm Surgical Co.

**Neuro Spinal**

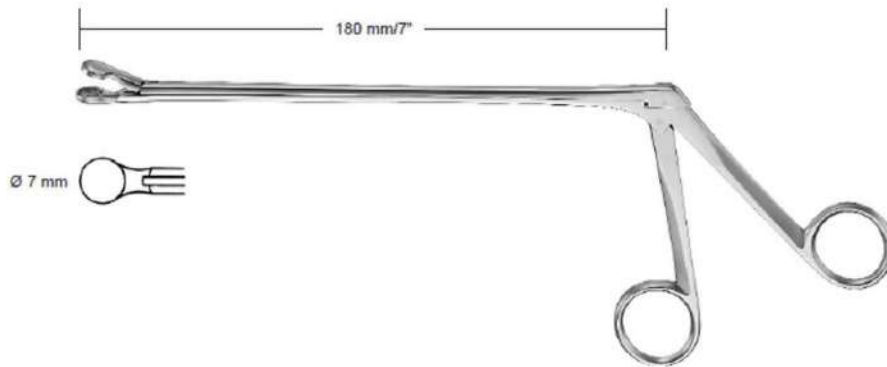

**OLDBERG**  
**40.445.25**  
25 cm/10"

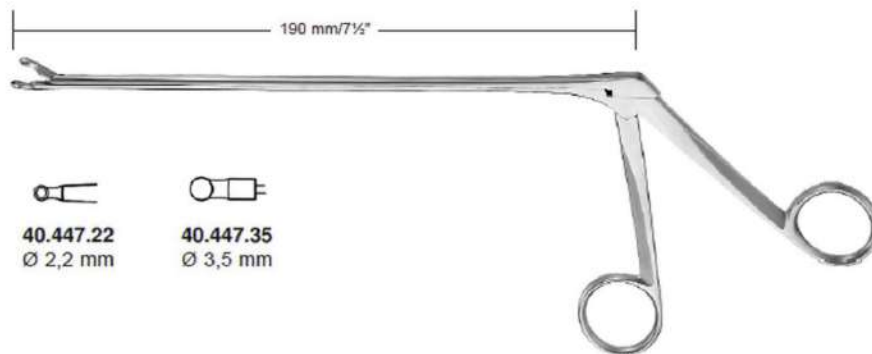

**YASARGIL**

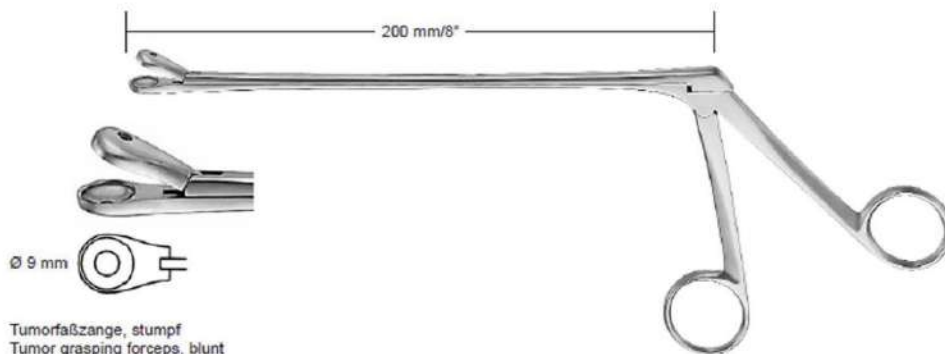

Tumorfaßzange, stumpf  
Tumor grasping forceps, blunt  
Pinces pour préhension de tumeurs, mousse  
Pinzas para agarrar tumores, romo  
Pinze per afferrare tumori, smusso

**LANDOLT**  
**40.448.20**



**TUFFRO**

The Mangalm Surgical Co.

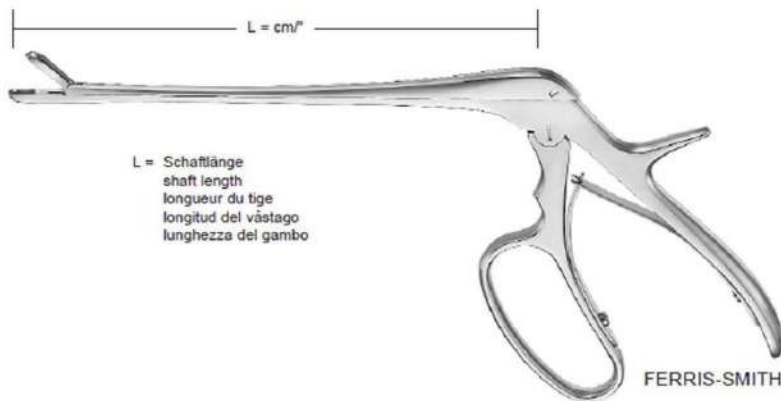

L = Schäftlänge  
shaft length  
longueur du tige  
longitud del vástago  
lunghezza del gambo

FERRIS-SMITH-CUSHING

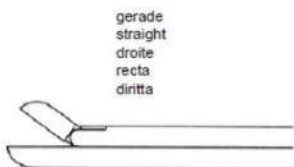

gerade  
straight  
droite  
recta  
diritta



nach oben  
upwards  
vers le haut  
hacia arriba  
in alto

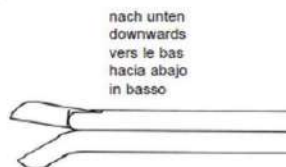

nach unten  
downwards  
vers le bas  
hacia abajo  
in basso

	16 cm/6¼"	18 cm/7"	16 cm/6¼"	18 cm/7"	16 cm/6¼"	18 cm/7"
2 x 10 mm		40.451.01		40.451.02		40.451.03
3 x 10 mm	40.450.01	40.452.01	40.450.02	40.452.02	40.450.03	40.452.03
4 x 10 mm		40.453.01		40.453.02		40.453.03

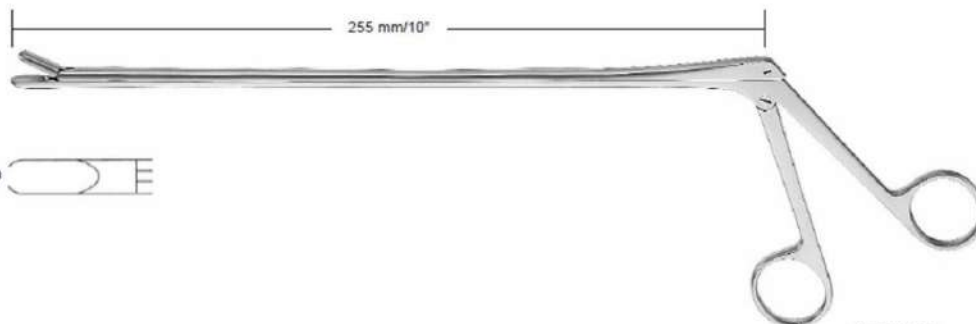

5,3 mm

40.457.53

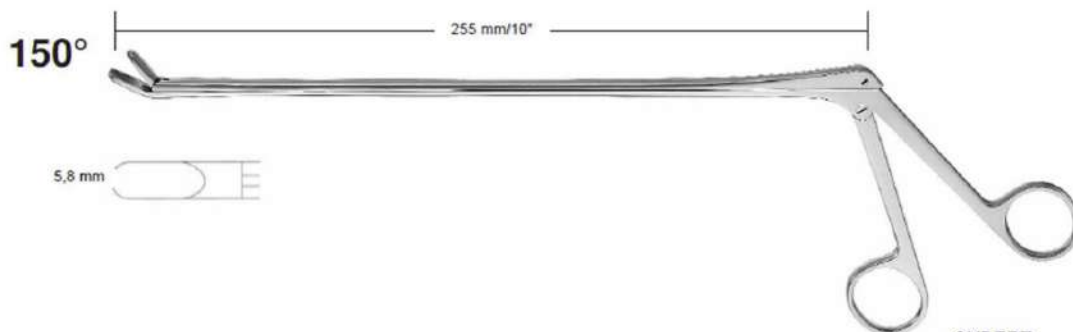

5,8 mm

SYPERT  
40.457.58

**Neuro Spinal**



**TUFFRO**

The Mangalm Surgical Co.

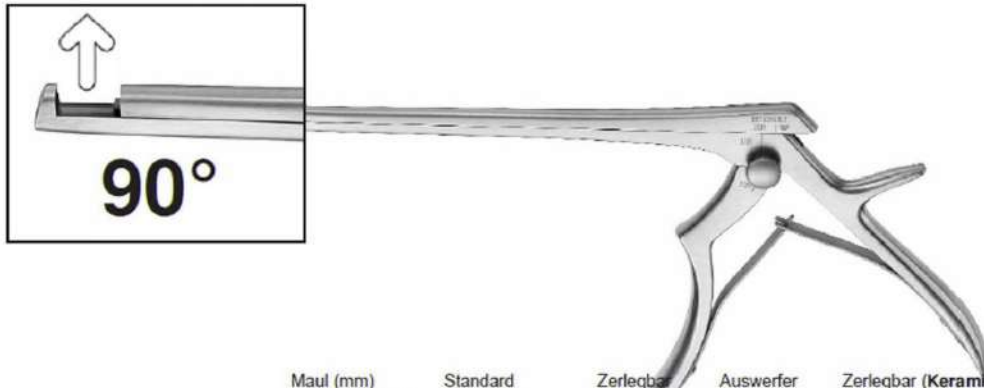
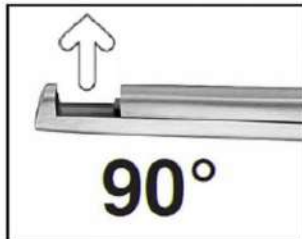

**Neuro Spinal**

	Maul (mm) Jaw Size (mm) mors (mm) boca (mm) morso (mm)	Standard Standard Standard Estándar Standard	Zerlegbar Dismantable Démontable Desmontable Smontabile	Auswerfer Ejector Éjecteur Expulsor Espulsore	Zerlegbar (Keramik) Dismantable (Ceramic) Démontable (Ceramic) Desmontable (Cerámica) Smontabile (Ceramica)	Auswerfer Ejector Éjecteur Expulsor Espulsore	
180 mm / 7"	1	40.510.01	40.496.01	-	40.496.01B	-	
	2	40.510.02	40.496.02	-	40.496.02B	-	
	3	40.510.03	40.496.03	☑	40.496.03B	☑	
	4	40.510.04	40.496.04	☑	40.496.04B	☑	
	5	40.510.05	40.496.05	☑	40.496.05B	☑	
	6	40.510.06	40.496.06	☑	40.496.06B	☑	
200 mm / 8"	1	40.510.11	40.496.11	-	40.496.11B	-	
	2	40.510.12	40.496.12	-	40.496.12B	-	
	3	40.510.13	40.496.13	☑	40.496.13B	☑	
	4	40.510.14	40.496.14	☑	40.496.14B	☑	
	5	40.510.15	40.496.15	☑	40.496.15B	☑	
	6	40.510.16	40.496.16	☑	40.496.16B	☑	
230 mm / 9"	1	40.510.21	40.497.02	-	40.497.02B	-	
	2	40.510.22	40.497.03	☑	40.497.03B	☑	
	3	40.510.23	40.497.04	☑	40.497.04B	☑	
	4	40.510.24	40.497.05	☑	40.497.05B	☑	
	5	40.510.25	40.497.06	☑	40.497.06B	☑	
	6	40.510.26					
dünnfuß thin foot plate	180 mm / 7"	1	40.510.31	40.496.21	-	40.496.21B	-
	2	40.510.32	40.496.22	-	40.496.22B	-	
	3	40.510.33	40.496.23	☑	40.496.23B	☑	
	4	40.510.34	40.496.24	☑	40.496.24B	☑	
	5	40.510.35	40.496.25	☑	40.496.25B	☑	
pointçonnage étroite	200 mm / 8"	2	40.510.42	40.496.32	-	40.496.32B	-
	3	40.510.43	40.496.33	☑	40.496.33B	☑	
	4	40.510.44	40.496.34	☑	40.496.34B	☑	
	5	40.510.45	40.496.35	☑	40.496.35B	☑	
	6	40.510.46	40.496.36	☑	40.496.36B	☑	
	punzonar estrecha	230 mm / 9"	2	40.510.52	40.497.12	-	40.497.12B
3		40.510.53	40.497.13	☑	40.497.13B	☑	
4		40.510.54	40.497.14	☑	40.497.14B	☑	
5		40.510.55	40.497.15	☑	40.497.15B	☑	
6		40.510.56	40.497.16	☑	40.497.16B	☑	
settite							





**TUFFRO**

The Mangalm Surgical Co.



	Maul (mm) Jaw Size (mm) mors (mm) boca (mm) morso (mm)	Standard Standard Standard Estándar Standard	Zerlegbar Dismantable Démontable Desmontable Smontabile	Auswerfer Ejector Éjecteur Expulsor Espulsore	Zerlegbar (Keramik) Dismantable (Ceramic) Démontable (Ceramica) Desmontable (Cerámica) Smontabile (Ceramica)	Auswerfer Ejector Éjecteur Expulsor Espulsore
180 mm / 7"	1	40.511.01	40.498.01	-	40.498.01B	-
	2	40.511.02	40.498.02	-	40.498.02B	-
	3	40.511.03	40.498.03	☑	40.498.03B	☑
	4	40.511.04	40.498.04	☑	40.498.04B	☑
	5	40.511.05	40.498.05	☑	40.498.05B	☑
	6	40.511.06	40.498.06	☑	40.498.06B	☑
200 mm / 8"	1	40.499.11	40.498.11	-	40.498.11B	-
	2	40.499.12	40.498.12	-	40.498.12B	-
	3	40.499.13	40.498.13	☑	40.498.13B	☑
	4	40.499.14	40.498.14	☑	40.498.14B	☑
	5	40.499.15	40.498.15	☑	40.498.15B	☑
	6	40.499.16	40.498.16	☑	40.498.16B	☑
230 mm / 9"	2	40.499.42	40.499.02	-	40.499.02B	-
	3	40.499.43	40.499.03	☑	40.499.03B	☑
	4	40.499.44	40.499.04	☑	40.499.04B	☑
	5	40.499.45	40.499.05	☑	40.499.05B	☑
	6	40.499.46	40.499.06	☑	40.499.06B	☑

dünnfuß thin foot plate	180 mm / 7"	1	40.499.21	40.498.21	-	40.498.21B	-
		2	40.499.22	40.498.22	-	40.498.22B	-
		3	40.499.23	40.498.23	☑	40.498.23B	☑
		4	40.499.24	40.498.24	☑	40.498.24B	☑
		5	40.499.25	40.498.25	☑	40.498.25B	☑
peignonnage étroite punzonar estrecha	200 mm / 8"	1	40.499.31	40.498.31	-	40.498.31B	-
		2	40.499.32	40.498.32	-	40.498.32B	-
		3	40.499.33	40.498.33	☑	40.498.33B	☑
		4	40.499.34	40.498.34	☑	40.498.34B	☑
		5	40.499.35	40.498.35	☑	40.498.35B	☑
sottile	230 mm / 9"	2	40.499.52	40.498.52	☑	40.498.52B	☑
		3	40.499.53	40.498.53	☑	40.498.53B	☑
		4	40.499.54	40.498.54	☑	40.498.54B	☑
		5	40.499.55	40.498.55	☑	40.498.55B	☑

**Neuro Spinal**



**TUFFRO**

The Mangalm Surgical Co.

**Neuro Spinal**

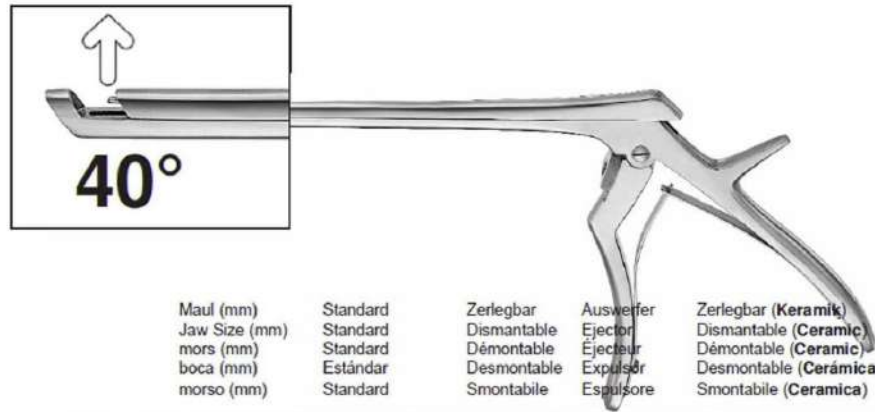

	Maul (mm) Jaw Size (mm) mors (mm) boca (mm) morso (mm)	Standard Standard Standard Estandar Standard	Zerlegbar Dismantable Démontable Desmontable Smontabile	Auswerfer Ejector Éjecteur Expulsor Espulsore	Zerlegbar (Keramik) Dismantable (Ceramic) Démontable (Céramic) Desmontable (Cerámica) Smontabile (Ceramica)	Auswerfer Ejector Éjecteur Expulsor Espulsore	
	180 mm / 7"	1	40.512.01	40.500.01	-	40.500.01B	-
		2	40.512.02	40.500.02	-	40.500.02B	-
		3	40.512.03	40.500.03	☑	40.500.03B	☑
		4	40.512.04	40.500.04	☑	40.500.04B	☑
		5	40.512.05	40.500.05	☑	40.500.05B	☑
		6	40.512.06	40.500.06	☑	40.500.06B	☑
	200 mm / 8"	2	40.511.22	40.501.02	-	40.501.02B	-
		3	40.511.23	40.501.03	☑	40.501.03B	☑
		4	40.511.24	40.501.04	☑	40.501.04B	☑
		5	40.511.25	40.501.05	☑	40.501.05B	☑
		6	40.511.26	40.501.06	☑	40.501.06B	☑
		230 mm / 9"	2	40.542.02	40.502.02	-	40.502.02B
		3	40.542.03	40.502.03	☑	40.502.03B	☑
		4	40.542.04	40.502.04	☑	40.502.04B	☑
		5	40.542.05	40.502.05	☑	40.502.05B	☑
		280 mm / 11"	2	40.511.32			
		3	40.511.33				
		4	40.511.34				
		5	40.511.35				
		6	40.511.36				
	dünnfuß thin foot plate	180 mm / 7"	1	40.511.11	40.500.11	-	40.500.11B
		2	40.511.12	40.500.12	-	40.500.12B	-
		3	40.511.13	40.500.13	☑	40.500.13B	☑
		4	40.511.14	40.500.14	☑	40.500.14B	☑
		5	40.511.15	40.500.15	☑	40.500.15B	☑
pointçonnage étroite punzonar estrecha	200 mm / 8"	1	40.511.41	40.501.11	-	40.501.11B	-
		2	40.511.42	40.501.12	-	40.501.12B	-
		3	40.511.43	40.501.13	☑	40.501.13B	☑
		4	40.511.44	40.501.14	☑	40.501.14B	☑
		5	40.511.45	40.501.15	☑	40.501.15B	☑
sottile	230 mm / 9"	2	40.542.12	40.502.12	-	40.502.12B	-
		3	40.542.13	40.502.13	☑	40.502.13B	☑
		4	40.542.14	40.502.14	☑	40.502.14B	☑
		5	40.542.15	40.502.15	☑	40.502.15B	☑



**TUFFRO**

The Mangalm Surgical Co.

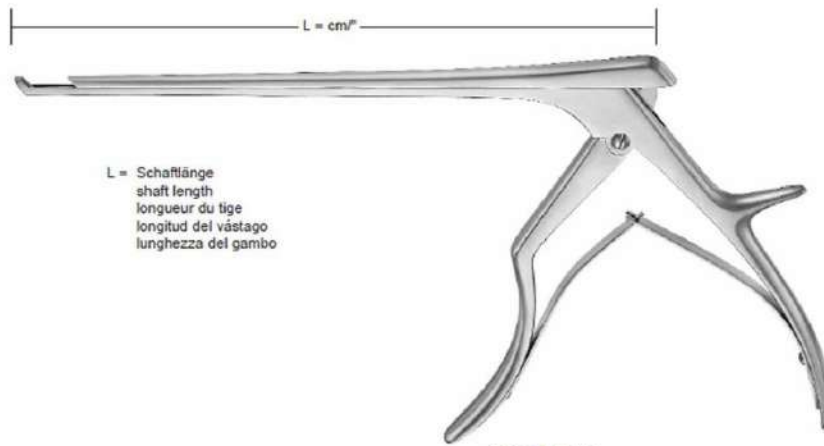

L = Schaftlänge  
shaft length  
longueur du tige  
longitud del vástago  
lunghezza del gambo

SCHLESING



15 cm/6"      20 cm/8"

15 cm/6"      20 cm/8"

3 mm      **40.530.03**      **40.532.03**

5 mm      **40.530.05**      **40.532.05**



15 cm/6"      20 cm/8"

15 cm/6"      20 cm/8"

3 mm      **40.534.03**      **40.536.03**

5 mm      **40.534.05**      **40.536.05**



15 cm/6"      20 cm/8"

3 mm      **40.538.03**      **40.540.03**

5 mm      **40.538.05**      **40.540.05**

**Neuro Spinal**



**TUFFRO**

The Mangalm Surgical Co.



**Neuro Spinal**

	Maul (mm) Jaw Size (mm) mors (mm) boca (mm) morso (mm)	Standard Standard Estándar Standard	Zerlegbar Dismantable Démontable Desmontable Smontabile	Auswerfer Ejector Éjecteur Expulsor Espulsore	Zerlegbar (Keramik) Dismantable (Ceramic) Démontable (Ceramic) Desmontable (Cerámica) Smontabile (Ceramica)	Auswerfer Ejector Éjecteur Expulsor Espulsore	
	180 mm / 7"	1	40.514.01	40.503.01	-	40.503.01B	-
		2	40.514.02	40.503.02	-	40.503.02B	-
		3	40.514.03	40.503.03	☑	40.503.03B	☑
		4	40.514.04	40.503.04	☑	40.503.04B	☑
		5	40.514.05	40.503.05	☑	40.503.05B	☑
	200 mm / 8"	1	40.514.21	40.503.21	-	40.503.21B	-
		2	40.514.22	40.503.22	-	40.503.22B	-
		3	40.514.23	40.503.23	☑	40.503.23B	☑
		4	40.514.24	40.503.24	☑	40.503.24B	☑
		5	40.514.25	40.503.25	☑	40.503.25B	☑
		6	40.514.26	40.503.26	☑	40.503.26B	☑
	230 mm / 9"	2	40.543.02	40.504.02	-	40.504.02B	-
		3	40.543.03	40.504.03	☑	40.504.03B	☑
		4	40.543.04	40.504.04	☑	40.504.04B	☑
		5	40.543.05	40.504.05	☑	40.504.05B	☑
		6	40.543.06	40.504.06	☑	40.504.06B	☑
	dünne thin foot plate	180 mm / 7"	1	40.514.11	40.503.11	-	40.503.11B
		2	40.514.12	40.503.12	-	40.503.12B	-
		3	40.514.13	40.503.13	☑	40.503.13B	☑
		4	40.514.14	40.503.14	☑	40.503.14B	☑
		5	40.514.15	40.503.15	☑	40.503.15B	☑
pointage étroite	200 mm / 8"	1	40.514.31	40.503.31	-	40.503.31B	-
		2	40.514.32	40.503.32	-	40.503.32B	-
		3	40.514.33	40.503.33	☑	40.503.33B	☑
		4	40.514.34	40.503.34	☑	40.503.34B	☑
		5	40.514.35	40.503.35	☑	40.503.35B	☑
punzonar estrecha sottile	230 mm / 9"	2	40.543.12	40.504.12	-	40.504.12B	-
		3	40.543.13	40.504.13	☑	40.504.13B	☑
		4	40.543.14	40.504.14	☑	40.504.14B	☑
		5	40.543.15	40.504.15	☑	40.504.15B	☑





**TUFFRO**

The Mangalm Surgical Co.

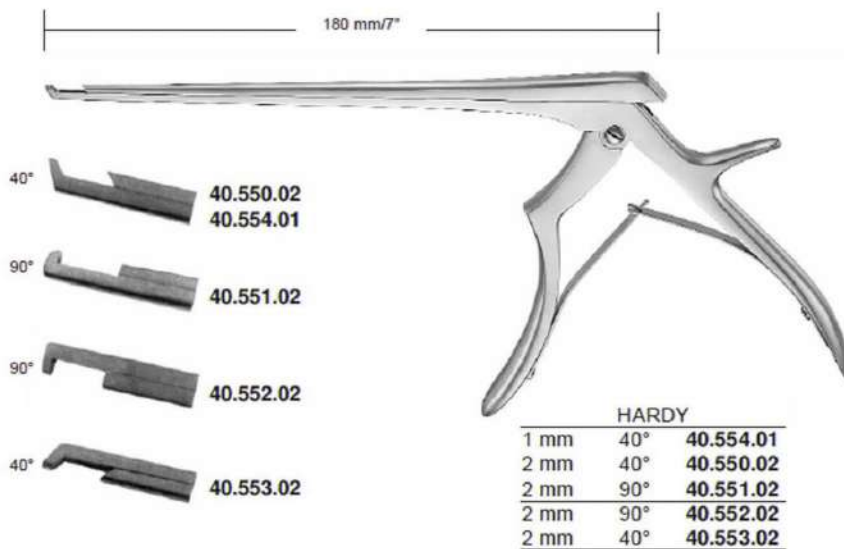
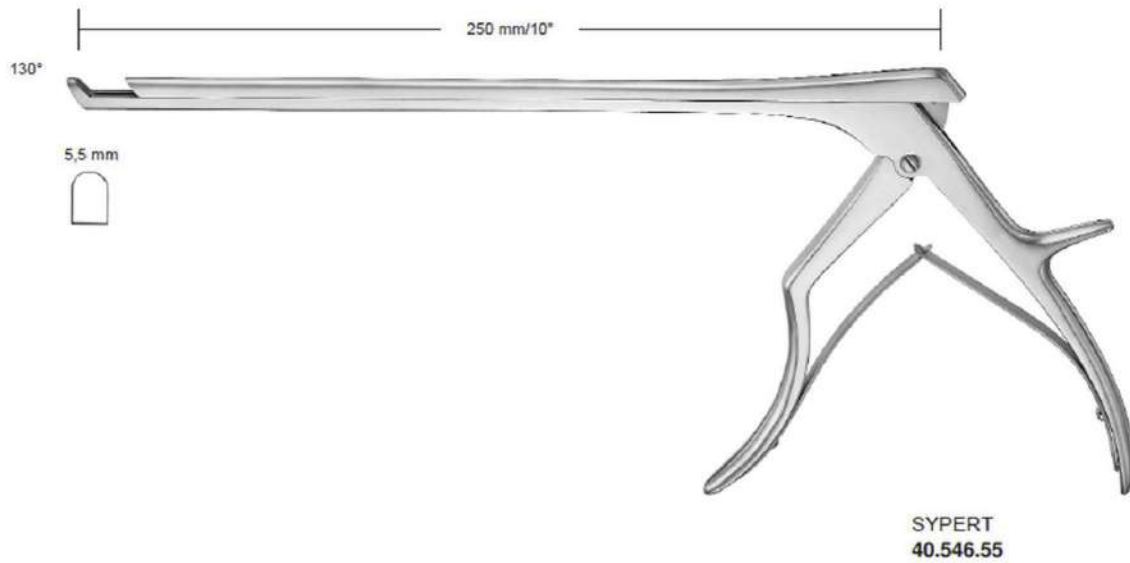

**Neuro Spinal**





**TUFFRO**

The Mangalm Surgical Co.

**Neuro Spinal**

oben schneidend  
up cutting  
tranchant en haut  
cortante por arriba  
tagliente in alto

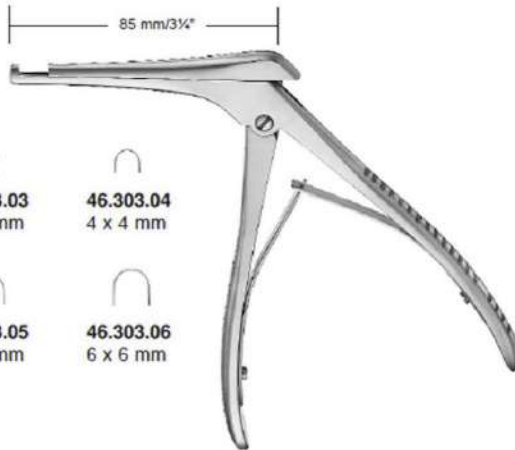

- 46.303.03 3 x 3 mm
- 46.303.04 4 x 4 mm
- 46.303.05 5 x 5 mm
- 46.303.06 6 x 6 mm

**KERRISON**  
17 cm/6 3/4"



**CITELLI**

1,0 mm	46.311.10
2,5 mm	46.311.25
4,0 mm	46.311.40

Keilbeinstanzen  
Sphenoid Bone Punches  
Pinces emporte-pièces pour sinus sphénoïdal  
Pinzas sacabocadas para esfenoides  
Pinze taglianti per seno sfenoidale

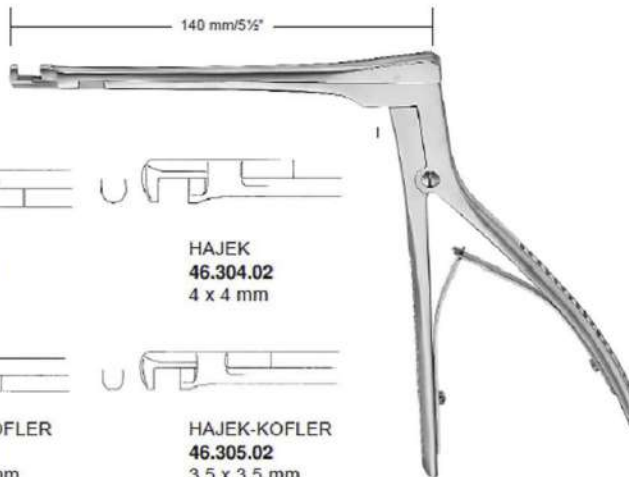

**BEYER**  
46.315.20



**HAJEK**  
46.304.01  
4 x 4 mm

**HAJEK**  
46.304.02  
4 x 4 mm



**HAJEK-KOFLER**  
46.305.01  
3,5 x 3,5 mm

**HAJEK-KOFLER**  
46.305.02  
3,5 x 3,5 mm

2.0 mm



**TUFFRO**

The Mangalm Surgical Co.

**Neuro Spinal**

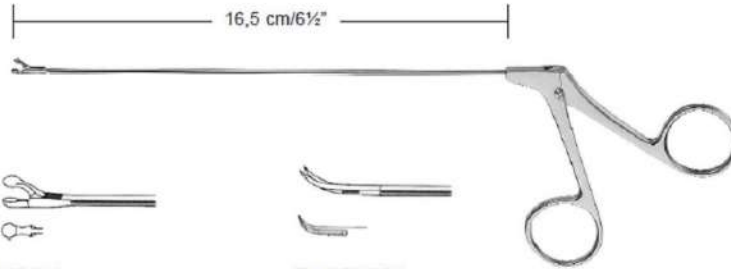

**NICOLA**  
**40.882.16**  
Ø 2,5 mm

Scharfezange mit löffelförmigem Maul  
Forceps, scoop-shaped  
pince, en forme de cuillère  
pinza, en forma de cuchara  
pinze, a forma di cucchiaio

**FAHLBUSCH**  
**40.881.16**

Schere, horizontal schneidend  
Schere, horizontal cutting, curved on flat  
Ciseaux, coupe horizontale  
Tijeras, corte horizontal  
Forbici, taglio orizzontale



**YASARGIL-NICOLA**  
**40.886.16**

Faßzange mit feinem Maul  
Forceps, long conical jaws  
pince, conique long mâchoires  
pinza, cónico largo mandíbulas  
pinze, lungo conico mascelle

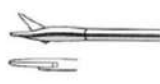

**NICOLA**  
**40.884.16**

Schere, gerade  
Scissors, straight  
Ciseaux, droit  
Tijeras, recta  
Forbici, dritta

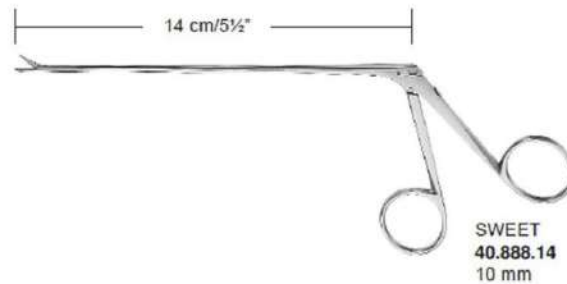

**SWEET**  
**40.888.14**  
10 mm

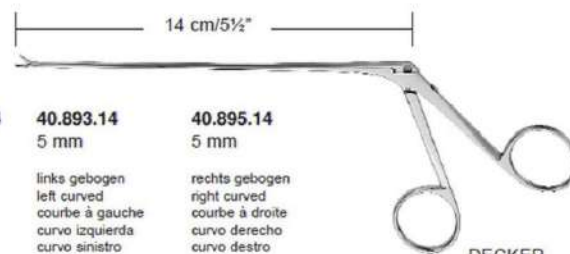

**40.892.14**  
5 mm

gerade  
Straight  
droite  
recta  
diritta

**40.893.14**  
5 mm

links gebogen  
left curved  
courbe à gauche  
curvo izquierda  
curvo sinistro

**40.895.14**  
5 mm

rechts gebogen  
right curved  
courbe à droite  
curvo derecho  
curvo destro

**DECKER**



**TUFFRO**

The Mangalm Surgical Co.

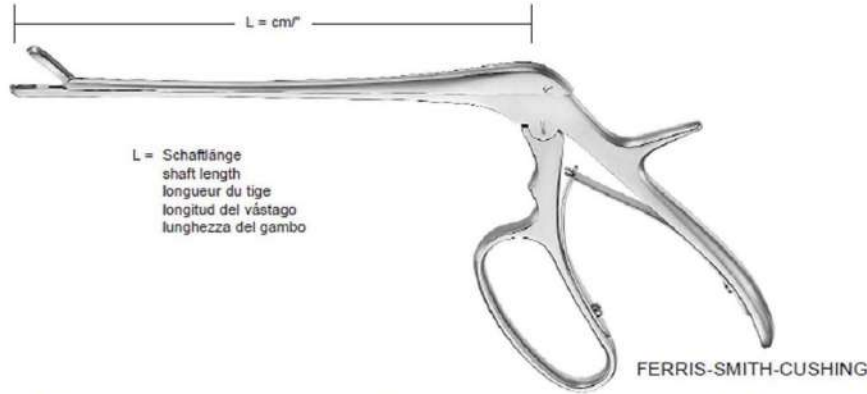

	16 cm/6¼"	18 cm/7"	16 cm/6¼"	18 cm/7"	16 cm/6¼"	18 cm/7"
2 x 10 mm		40.451.01		40.451.02		40.451.03
3 x 10 mm	40.450.01	40.452.01	40.450.02	40.452.02	40.450.03	40.452.03
4 x 10 mm		40.453.01		40.453.02		40.453.03

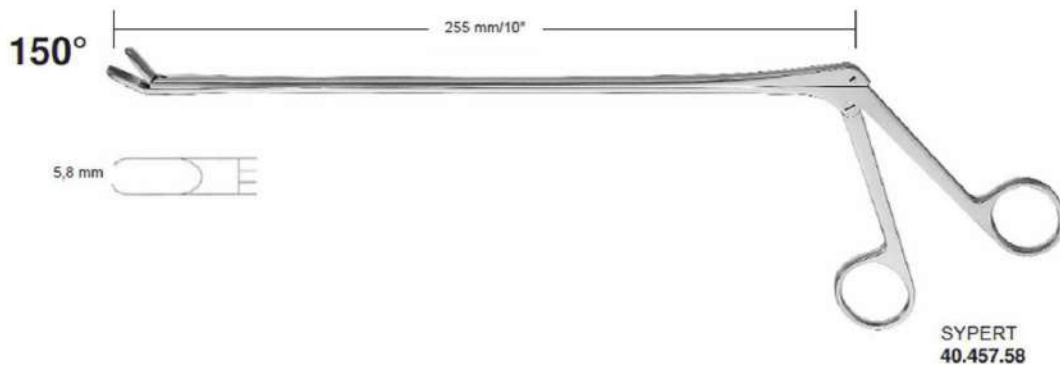
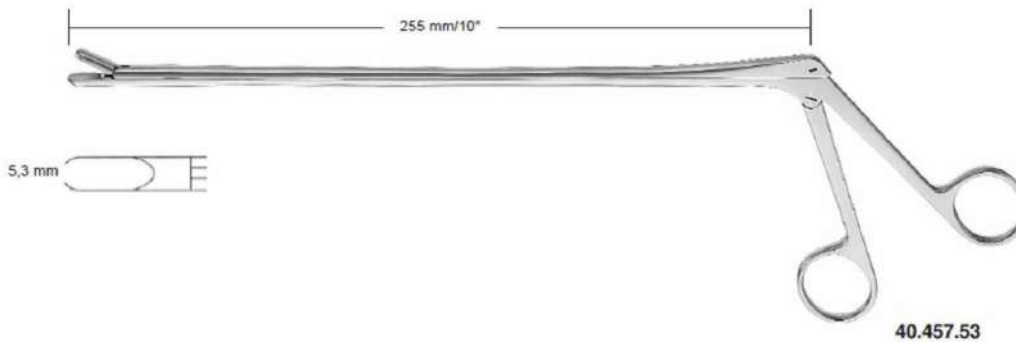

**Neuro Spinal**



**TUFFRO**

The Mangalm Surgical Co.

**Neuro Spinal**

gerade  
straight  
droite  
recta  
diritta

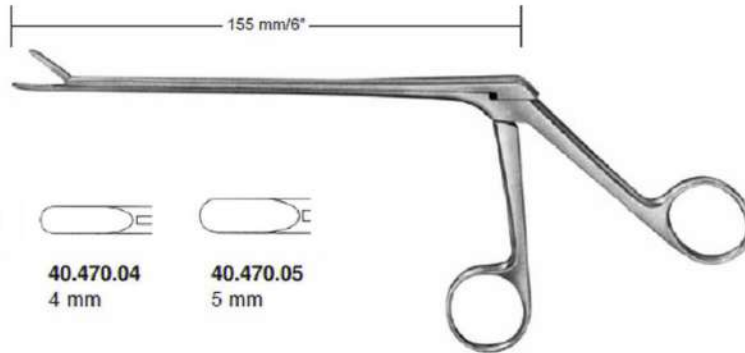

CASPAR

- 40.470.02 2 mm
- 40.470.03 3 mm
- 40.470.04 4 mm
- 40.470.05 5 mm

nach oben  
upwards  
vers le haut  
hacia arriba  
in alto

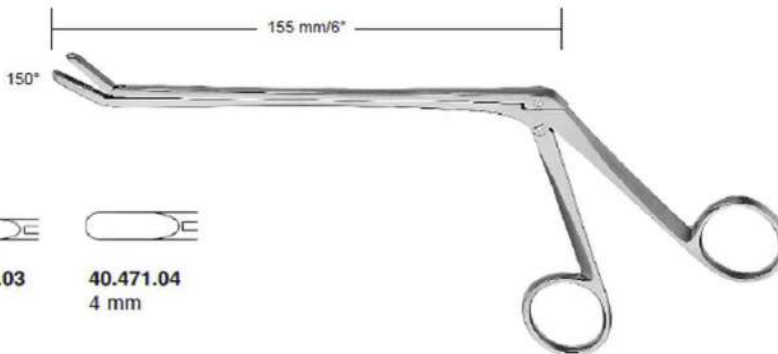

CASPAR

- 40.471.02 2 mm
- 40.471.03 3 mm
- 40.471.04 4 mm

nach unten  
downwards  
vers le bas  
hacia abajo  
in basso

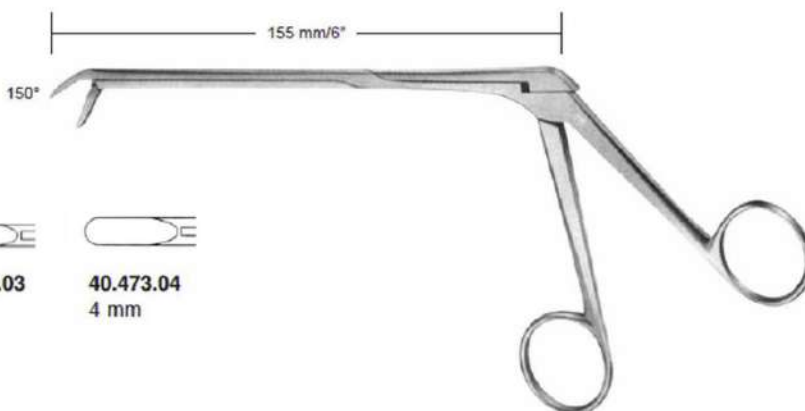

CASPAR

- 40.473.02 2 mm
- 40.473.03 3 mm
- 40.473.04 4 mm



CASPAR  
15 cm/6"

90 mm



CASPAR  
16,5 cm/6½"

**18.720.00**

Gegensperrer komplett,  
für ventrale cervicale Fusionsoperationen,  
mit 5 Blättern **18.716.45 - 18.716.65**

Retractor complete,  
for ventral cervical fusion operations  
with 5 blades **18.716.45 - 18.716.65**

Ecarteurs complet,  
chacun avec deux valves interchangeables  
avec 5 valves **18.716.45 - 18.716.65**

Separadores completo,  
con 5 valvas enchufables de c.u. **18.716.45 - 18.716.65**

Divaricatori completo,  
con 5 valve ad innesto **18.716.45 - 18.716.65**



18.716.45 - 18.716.65

**18.720.15**

Sperrer allein  
Spreader only  
Ecarteur seul  
Separador suelto  
Divaricatore solo

**18.721.00**

Gegensperrer komplett,  
für ventrale cervicale Fusionsoperationen,  
mit 5 Blättern **18.716.45 - 18.716.65**

Retractor complete,  
for ventral cervical fusion operations  
with 5 blades **18.716.45 - 18.716.65**

Ecarteurs complet,  
chacun avec deux valves interchangeables  
avec 5 valves **18.716.45 - 18.716.65**

Separadores completo,  
con 5 valvas enchufables de c.u. **18.716.45 - 18.716.65**

Divaricatori completo,  
con 5 valve ad innesto **18.716.45 - 18.716.65**



18.716.45 - 18.716.65

**18.721.15**

Sperrer allein  
Spreader only  
Ecarteur seul  
Separador suelto  
Divaricatore solo





**TUFFRO**

The Mangalm Surgical Co.

**Neuro Spinal**



CASPAR

**18.723.00**

Sperrer komplett mit  
5 medialen Blättern 18.718.40 - 18.718.60  
5 lateralen Blättern 18.719.40 - 18.719.60

Retractor complete with  
5 medial blades 18.718.40 - 18.718.60  
5 lateral blades 18.719.40 - 18.719.60

Ecarteurs complet avec  
5 médial valves 18.718.40 - 18.718.60  
5 latéral valves 18.719.40 - 18.719.60

Separadores completo con  
5 medial valvas 18.718.40 - 18.718.60  
5 lateral valvas 18.719.40 - 18.719.60

Divaricatori completo con  
5 media valve 18.718.40 - 18.718.60  
5 laterale valve 18.719.40 - 18.719.60

**18.723.12**

Sperrer allein  
Spreader only  
Ecarteur seul  
Separador suelto  
Divaricatore solo



18.718.40 - 18.718.60



18.719.40 - 18.719.60

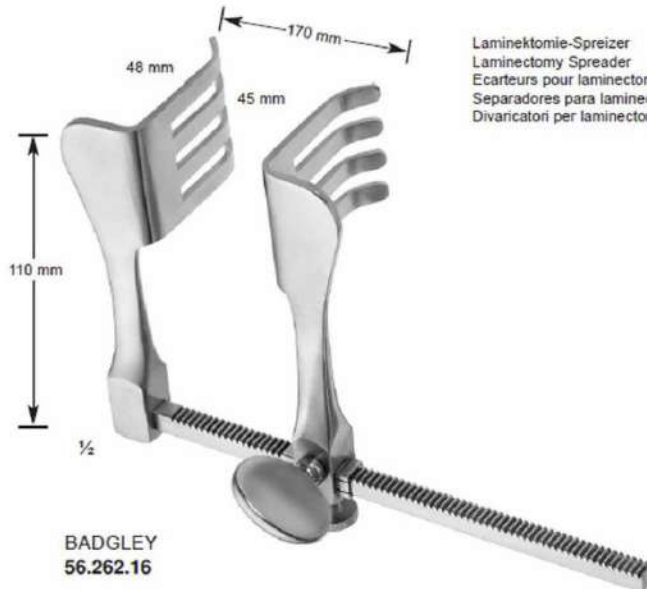

BADGLEY  
56.262.16

Laminektomie-Spreizer  
Laminectomy Spreader  
Ecarteurs pour laminectomie  
Separadores para laminectomia  
Divaricatori per laminectomia



**TUFFRO**

The Mangalm Surgical Co.

**CASPAR**  
**18.736.01**

Distraktor allein  
Distractor only  
DISTRACTEUR seulement  
Distractor sólo  
Distractor solo



**CASPAR**  
**18.736.00**

Wirbelkörperdistraktor, für Eingriffe mittels rechtsseitigem Zugang zu C5 - T<sub>1/2</sub> und linksseitigem Zugang zur oberen HWS, bestehend aus:

- 18.736.01** 1 Distraktor allein
- 18.736.02** 1 Bohrflehre
- 18.736.10** 1 Bohrer
- 18.736.16** 2 Distractionsschrauben
- 18.736.10** 1 Schraubendreher

Vertebral body distractor, for use in surgical procedures from **the right** approach for C 5 through T<sub>1/2</sub> and from **the left** approach for the upper cervical spine, consisting of:

- 18.736.01** 1 Distractor only
- 18.736.02** 1 Drill guide
- 18.736.10** 1 Twist Drill
- 18.736.16** 2 Distraction Screws
- 18.736.10** 1 Screw driver



**CASPAR**  
**18.737.01**

Distraktor allein  
Distractor only  
DISTRACTEUR seulement  
Distractor sólo  
Distractor solo

**CASPAR**  
**18.737.00**

Wirbelkörperdistraktor, für Eingriffe mittels linksseitigem Zugang zu C5 - T<sub>1/2</sub> und linksseitigem Zugang zur oberen HWS, bestehend aus:

- 18.737.01** 1 Distraktor allein
- 18.737.02** 1 Bohrflehre
- 18.736.10** 1 Bohrer
- 18.736.16** 2 Distractionsschrauben
- 18.736.10** 1 Schraubendreher

Vertebral body distractor, for use in surgical procedures from **the left** approach for C 5 through T<sub>1/2</sub> and from **the left** approach for the upper cervical spine, consisting of:

- 18.737.01** 1 Distractor only
- 18.737.02** 1 Drill guide
- 18.736.10** 1 Twist Drill
- 18.736.16** 2 Distraction Screws
- 18.736.10** 1 Screw driver

DISTRACTEUR corps vertébral, pour utilisation dans des interventions chirurgicales à partir de la gauche approche de C 5 à T<sub>1/2</sub> et de la gauche approche de la colonne cervicale supérieure, composée de:

- 18.737.01** 1 distracteur seul
- 18.737.02** 1 guide-meche
- 18.736.10** 1 meche
- 18.736.16** 2 vis a distraction
- 18.736.10** 1 tournevis

**Neuro Spinal**



**TUFFRO**

The Mangalm Surgical Co.

**Neuro Spinal**

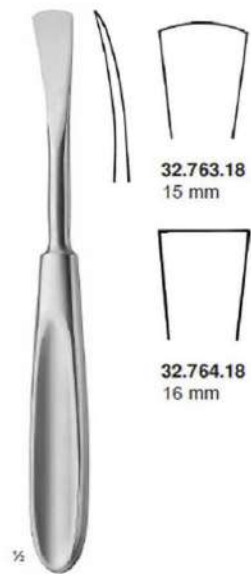

**CUSHING**  
18 cm/7"

32.763.18  
15 mm

32.764.18  
16 mm

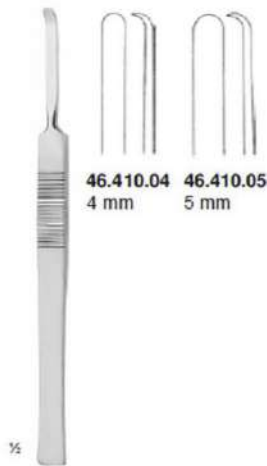

**McKENTY**  
15 cm/6"

46.410.04  
4 mm

46.410.05  
5 mm



**SEWALL**  
46.436.20  
20 cm/8"

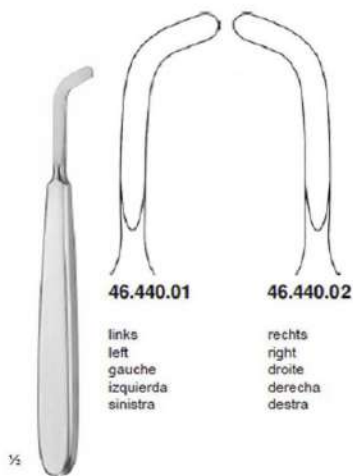

14 cm/5½"

46.440.01

46.440.02

links  
left  
gauche  
izquierda  
sinistra

rechts  
right  
droite  
derecha  
destra



**WILLIGER**  
82.897.13  
13 cm/5"

5 mm



**WILLIGER**  
82.898.17  
17 cm/6¾"

7 mm



**WILLIGER**  
82.899.16  
16 cm/6¼"

5,5 mm



**TUFFRO**

The Mangalm Surgical Co.

**Neuro Spinal**

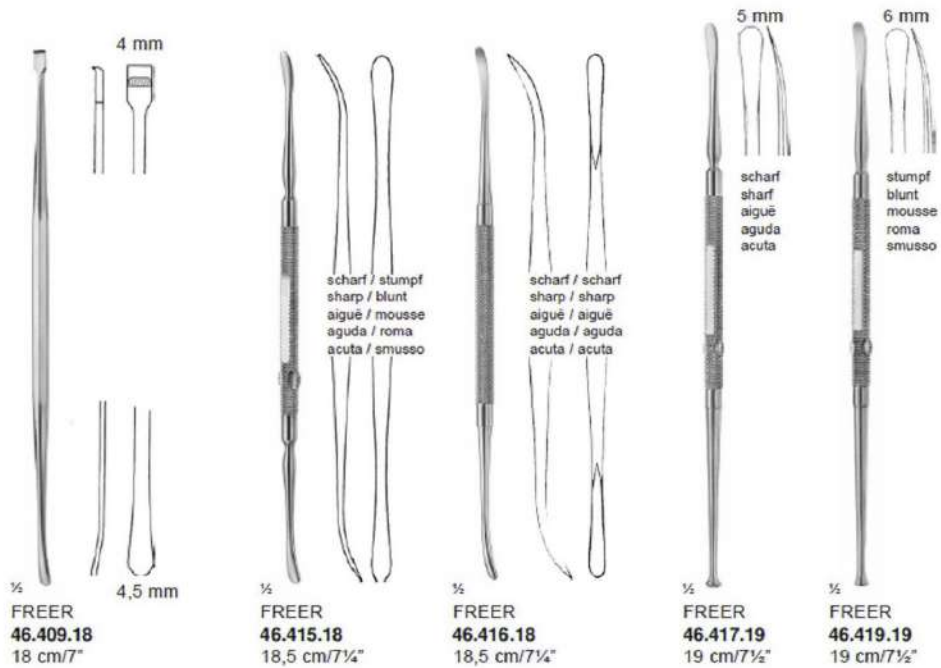
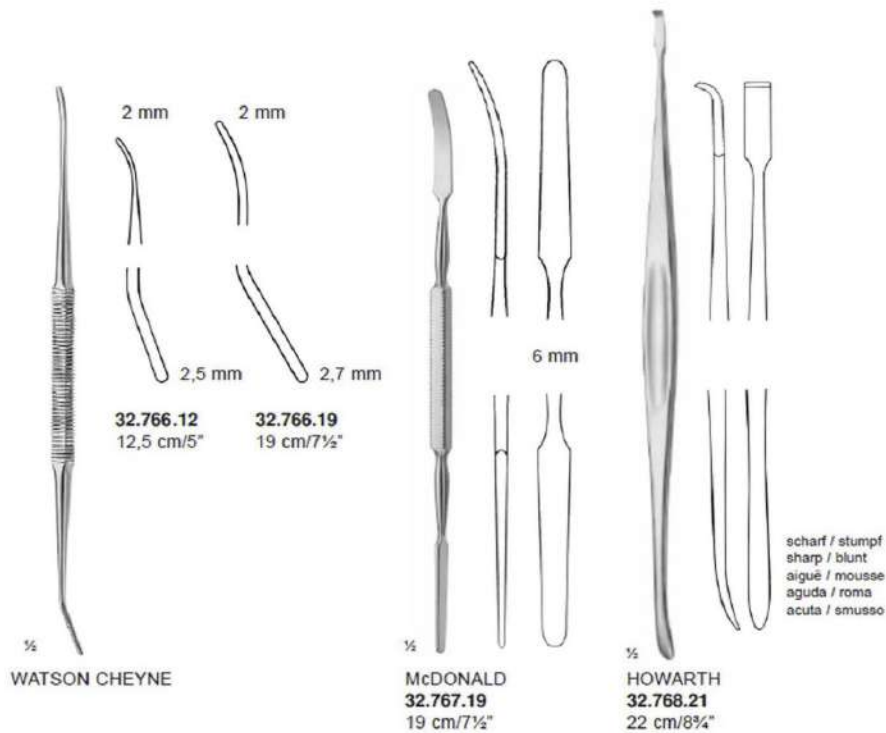



**TUFFRO**

The Mangalm Surgical Co.

**Neuro Spinal**

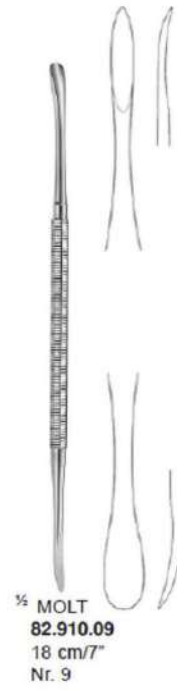
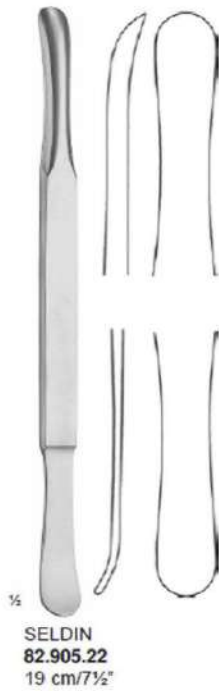
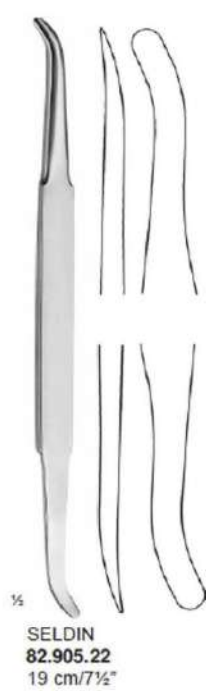
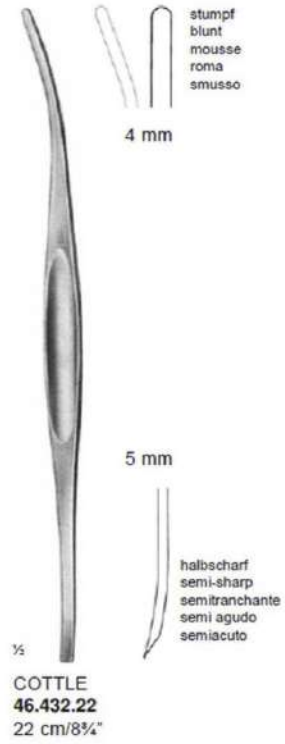





Spreizzange für Spekula  
Spreading forceps for specula  
Pince écartante pour spéculums  
Pinza dilatadora para espéculos  
Pinza divaricatrice per specoli

**LANDOLT**  
**40.804.21**  
21 cm/8¼"



Lamina-Meißel  
Lamina Chisel  
Ciseau burin pour les lames de l'arc vertébral  
Cinzel para lámina  
Scalpello per lamina

**PAPAVERO**  
**40.803.22**  
22 cm/8¾"



**RAY**  
**40.810.04**  
19 cm/7½"



**RAY**  
19 cm/7½"



**40.811.03**  
Ø 3 mm

**40.811.04**  
Ø 4 mm

**40.811.05**  
Ø 5 mm



**40.812.03**  
Ø 3 mm

**40.812.04**  
Ø 4 mm

**40.812.05**  
Ø 5 mm



**40.813.03**  
Ø 3 mm

**40.813.04**  
Ø 4 mm

**40.813.05**  
Ø 5 mm



**40.814.03**  
Ø 3 mm

**40.814.04**  
Ø 4 mm

**40.814.05**  
Ø 5 mm